



Poseidon2 family

Poseidon2 is a family of products for remote monitoring and control over a LAN.

The family consists of several versions designed for different uses (19" cabinets, data centers, electric cabinets, ...). Individual Poseidon2 models differ by the number and types of supported sensors; other features are identical.

Safety information

The device complies with regulations and industrial standards in force in the Czech Republic and the European Union. The device has been tested and is supplied in working order. To keep the device in this condition, it is necessary to adhere to the following safety and maintenance instructions.

Never remove the device cover if the relay terminals are connected to the electrical network!

Using the device in a manner other than prescribed by the manufacturer may cause its safeguards to fail!

The power supply outlet or disconnection point must be freely accessible.

The device must not be used in particular under any of the following conditions:

- The device is noticeably damaged
- The device does not function properly
- Unfastened parts can move inside the device
- The device has been exposed to moisture or rain
- The device has been serviced by unauthorized personnel
- The power adapter or power supply cable are noticeably damaged
- If the device is used in a manner other than designed for, the protection provided by the device may fail.
- The local electrical system must include a power switch or a circuit breaker and overcurrent protection.

The manufacturer warrants the device only if it is powered by the supplied power adapter or an approved power supply.

If you have any problems with installing or operating the device, please contact technical support:

HW group s.r.o.

http://www.hw-group.com

E-mail: support@HWg.cz

Phone: +420 222 511 918

Formanská 296

Praha 4, 149 00

Czech Republic

When contacting technical support, please keep at hand the exact type of your device (at the type plate) and, if possible, the firmware version (see later in this manual).

Contents

Safety information	2	SNMP	47
Poseidon2 models	4	Email	50
Poseidon2 3266	4	GSM	52
Poseidon2 3268	4	Log & Time	54
Poseidon2 3468	5	Portal	56
Poseidon2 4002	5	MQTT	58
Feature comparison	6	Sensors	60
Connectors	7	Inputs	62
Setting up	8	Outputs	63
Connecting the cables	8	Virtual Outputs (VDO)	65
Configuring the IP address – HWg Config	8	System	66
Configuring network parameters	9	Update Firmware	67
WWW interface of the device	10	Software applications	67
Web interface	11	HWg-PDMS	67
Connecting the sensors	26	HWg-Trigger	68
1-Wire Bus (RJ11) sensors	26	PosDamIO	68
RS-485 (RJ45) sensors	26	SensDesk.com	69
Common features of the Poseidon2 family	27	Connecting Poseidon2 to SensDesk	70
Displayed readings	27	PosDamIO and SDK	74
Input / sensor in alarm state	27	Formats and interfaces	74
Calibration	28		
Sensor hysteresis	28		
Supported interfaces (in detail)	29		
Connectors and connections	29		
Dry Contact inputs	30		
RJ11 – 1-Wire bus	31		
1-Wire UNI (RJ11)	31		
1-Wire (UNI) bus	32		
RJ45 – RS-485	33		
User interface	39		
HWg Config	39		
WEB interface	40		
General	40		
General Setup	42		
Security	44		

Poseidon2 models

Poseidon2 3266

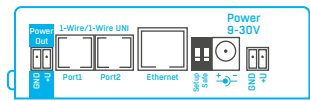
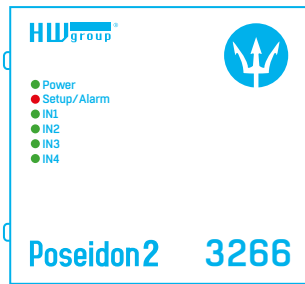

Poseidon2 3268

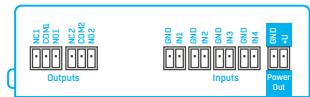
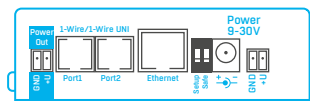
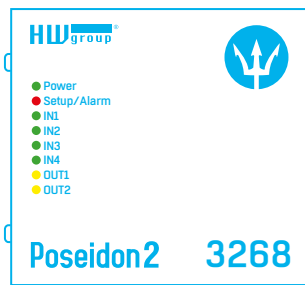

Poseidon2 3468

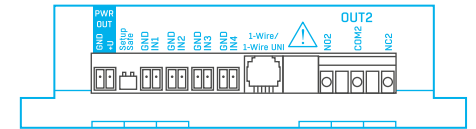
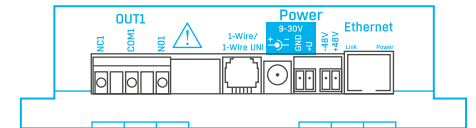
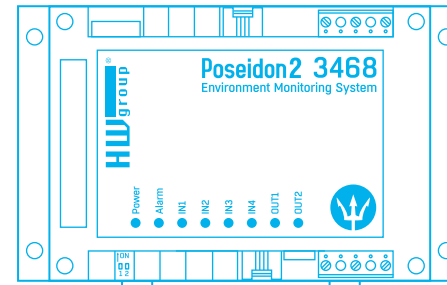

Poseidon2 4002

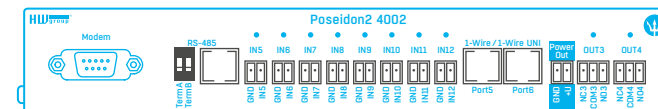
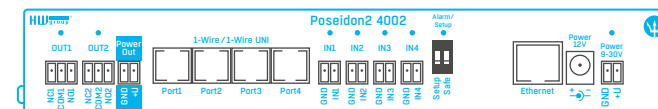
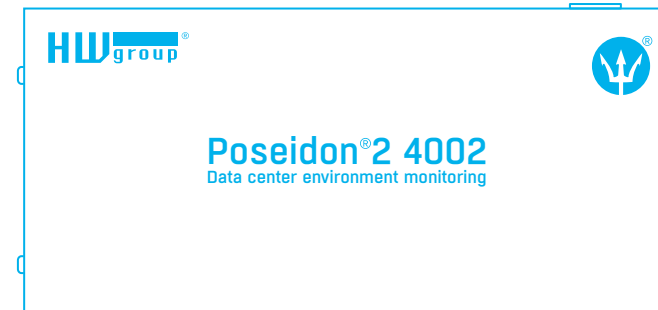

Feature comparison

	Poseidon2 3266	Poseidon2 3268	Poseidon2 3468	Poseidon2 4002
Ethernet	100 Mbps	100 Mbps	100 Mbps	100 Mbps
VLAN	future	future	future	future
HTTP	✓	✓	✓	✓
HTTPS	✓	✓	✓	✓
DHCP	✓	✓	✓	✓
SNMP v1	✓	✓	✓	✓
SNMP v3	✓	✓	✓	✓
SNMP trap	✓	✓	✓	✓
Trap destinations	5	5	5	5
SNTP	✓	✓	✓	✓
SMTP	✓	✓	✓	✓
SMTP TLS	✓	✓	✓	✓
E-mail destinations	5	5	5	5
SMS / Local RS-232	✗	✗	✗	✓
SMS / netGSM	✓	✓	✓	✓
SMS destinations	5	5	5	5
Logger	✓	✓	✓	✓
Logger records	250 000	250 000	250 000	250 000
HWg-Push protocol	✓	✓	✓	✓
IPv6	✓	✓	✓	✓
Comm monitor	✓	✓	✓	✓
DO Local conditions	✓	✓	✓	✓
1-Wire sensors	8	8	8	16
1-Wire UNI support	✓	✓	✓	✓
RS-485 support	✗	✗	✗	✓
RS-485 sensors	✗	✗	✗	24
M-Bus meters	✗	✗	✗	✗
Modbus / TCP	✓	✓	✓	✓
E-mail alarm reminder	✓	✓	✓	✓
E-mail periodical status	✓	✓	✓	✓
Power Input 1	9-30 V	9-30 V	9-30 V	9-30 V
Power Input 2	✗	✗	48 V DC	✗
DI (Digital inputs)	4	4	4	12
DO (Digital outputs)	0	2	2	4
DO max. load	✗	50 V / 1 A	230 V / 10 A	50 V / 1 A
Operating temperature	-30..85 °C	-30..85 °C	-30..50 °C	-30..85 °C

Connectors

Ethernet

Ethernet 100Base-T (10/100Mbit). When connected, the green “Link” LED at the connector lights up to indicate proper connection. When communicating, the yellow „Activity” LED flashes.

Power

The green LED indicates that the device is powered. The power is always in the range of 9–30 V. Poseidon2 3468 additionally supports 48 V. PoE (Power Over Ethernet) modules can be added on a per-project basis.

PowerOut

Used to power sensors and accessories. Power Out is directly connected to the 9-30 V input. For units featuring 48 V or PoE power input, this output can source 12 V / 300 mA.

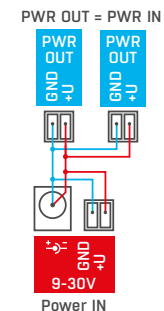

1-Wire/1-Wire UNI

Used to connect 1-Wire / 1-Wire UNI sensors by HW group. Each port can be directly connected to a bus with max. 60 m in length and max. 2 sensors (type 1-Wire / UNI). For details, see *Connecting the sensors*.

RS-485 (Poseidon2 4002 only)

Used to connect RS-485 sensors by HW group. The TermA and TermB switches control line termination. For details, see *Connecting the sensors*.

Inputs

INx – Dry Contact inputs. Inputs always share a common ground (GND). The corresponding green LED indicates a closed contact. There is a pulse counter at each input.

Outputs

OUTx – Relay outputs with NO/NC contacts. When idle, NCx (Normally Closed) + COMx (Common) are connected. When activated, NOx (Normally Open) + COMx are connected. Yellow LEDs indicate activated outputs.

Alarm/Setup LED

The red LED indicates device state: continuously on means Alarm (a sensor or an input outside of the safe range), flashing means TCP or Serial Setup mode.

DIP1/DIP2 switches

DIP1 – activates Serial Setup mode / restores factory defaults. To restore factory defaults, quickly toggle the switch 3× within the first 5 seconds after powering up the device.

DIP2 – Safe mode – activates HW protection of configuration settings. No settings can be changed.

First steps

1. Connecting the cables

- Turn the unit and note its MAC address that is printed on the label on the side.
- Set the switches: **DIP1=Off, DIP2=Off**.
- Connect Poseidon2 to the Ethernet (with a patch cable to a switch, cross-over cable to a PC), RJ-45 port.
- Plug the power adapter into a mains outlet and connect it to the Poseidon2 power jack.
- The green **POWER** LED lights up.
- If the Ethernet connection works properly, the green **LINK** LED lights up after a short while, and then flashes whenever data is transferred (activity indication).

2. Configuring the IP address – HWg Config

HWg Config utility – root directory of the supplied CD (Windows and Linux versions).
Also available for download at www.HW-group.com -> [Software](#) -> [HWg Config](#).

- Click the icon to launch **HWg Config**. The program automatically looks for connected devices.
- Automatic device discovery works only in the local network.
- To identify a particular Poseidon2 unit, look at the MAC address on the label at the bottom of the unit.
- Double-click a MAC address to open a basic device configuration dialog.

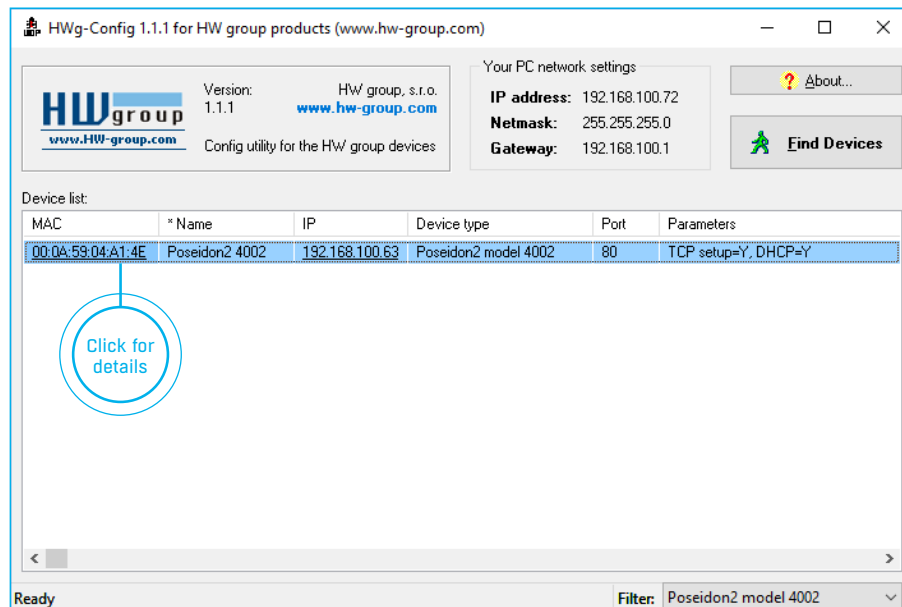

First steps

3. Configuring network parameters

- IP address / HTTP port (80 by default)
- Network mask
- Gateway IP address for your network
- Device name (optional)

Click **Apply Changes** to save the settings.

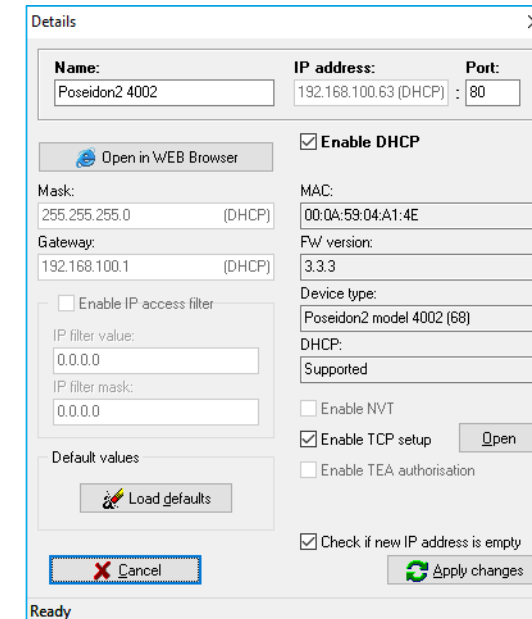

To configure the IP address, you may also use: **HWg Config for Linux**.



Important

- To reset the device to factory defaults, toggle DIP1 several times within 5 seconds after powering up the device.
- No configuration changes can be stored while DIP2=0n. To change the IP address, set DIP2=Off.

4. WWW interface of the device

To open the WWW interface of the device:

- Enter the device IP address in a web browser.
- Click the IP address in **HWg-Config**.
- Click the underlined IP address in HWg SETUP.
- The WWW page displays current states of devices and sensors.

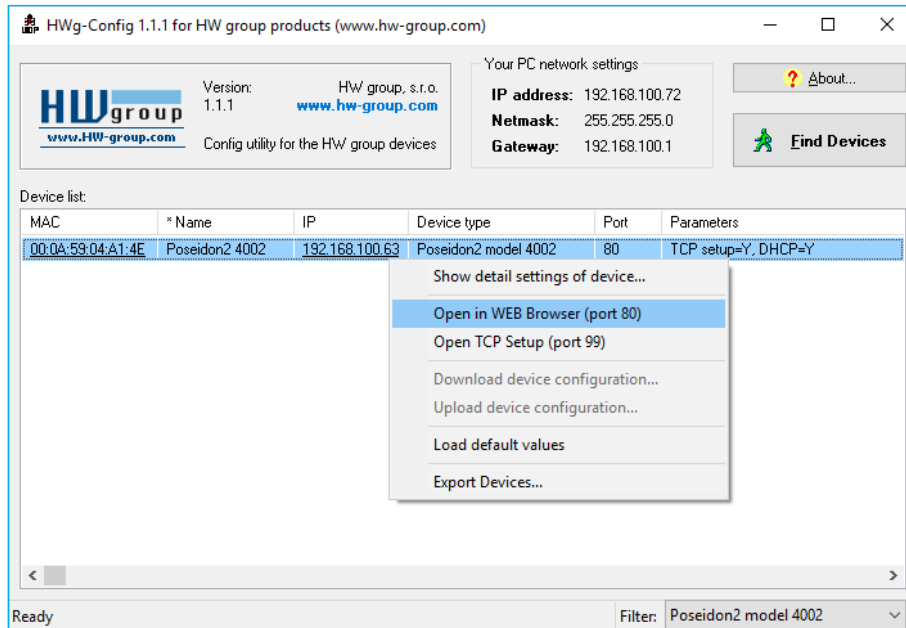

Web interface

- General:** overview of the readings
- General Setup:** IP address, DNS
- Security:** IP filter, security (username/password), HTTPS certificates
- SNMP:** SNMP/SNMP Trap configuration (ports and alarm recipients)
- Email:** configuration and test
- GSM:** configuration and test when working with a remote SMS-GW
- Log & Time:** time configuration, NTP server
- Portal:** connection to a remote portal
- MQTT:** configuration of the MQTT protocol for IoT services
- Inputs:** control of inputs, setting alarm parameters
- Outputs:** control of outputs, setting their parameters
- Virtual Outputs:** control of outputs from another Poseidon2 and Damocles2, B2B
- System:** firmware upgrade, save/restore configuration, etc.

General

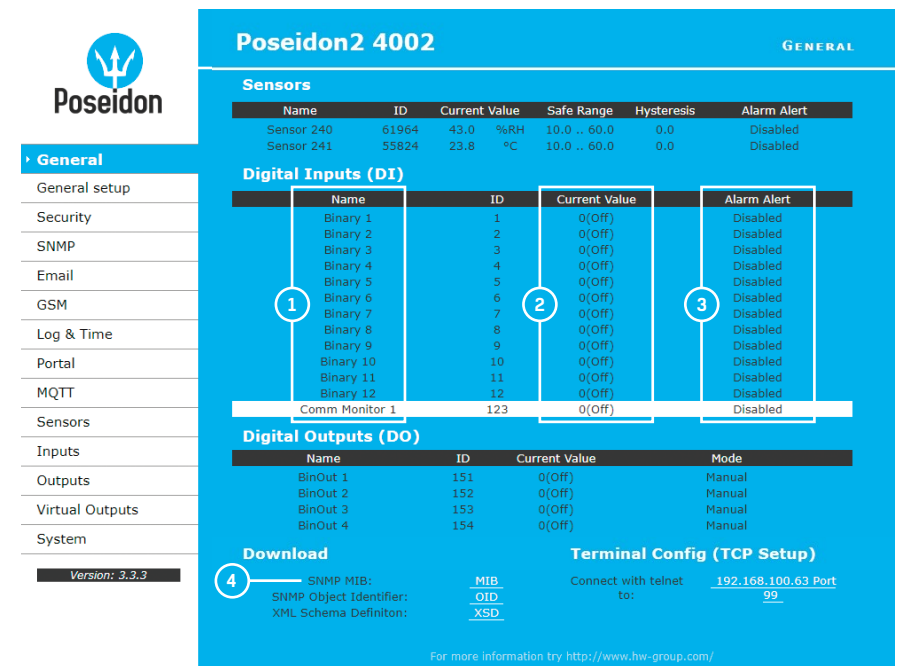

- 1 User-defined DI names
- 2 Alarm thresholds
- 3 Action when value out of range
- 4 MIB file for SNMP software

Note: For more information, see the detailed web interface description (2nd half of the manual).

General Setup

Device

Name	Value
Device Name:	Poseidon2 4002

Network Settings

Name	Value
IP Address:	192.168.100.63
Submask:	255.255.255.0
Gateway:	192.168.100.1
Primary DNS:	192.168.100.237
Secondary DNS:	192.168.100.250
HTTP Port:	80 0=dis, def 80
HTTPS Port:	443 0=dis, def 443
TCP Telnet Setup:	99 0=dis, def 99
Modbus TCP Port:	502 0=dis, def 502
DHCP Client:	<input checked="" type="checkbox"/>

IPV6

Name	Value
Enable IPV6:	<input type="checkbox"/>
Autoconfig IP parameters:	
Link Local Address:	
IP Address / Prefix Length:	
Gateway:	
Primary DNS:	
Secondary DNS:	

Other settings and information

Name	Value
Display temperature in:	Celsius [°]
System temperature in:	Celsius [°]
Syslog IP Address:	0.0.0.0
HW Security Protection:	Disabled

For more information try <http://www.hw-group.com/>

1 Device name, e.g. "First floor 1"

Note: For more information, see the detailed web interface description (2nd half of the manual).

Security

IP Access Filter

IP Address Value	IP Mask Range	HTTP	SNMP
0.0.0.0	0.0.0.0	<input type="checkbox"/>	<input type="checkbox"/>
0.0.0.0	0.0.0.0	<input type="checkbox"/>	<input type="checkbox"/>
0.0.0.0	0.0.0.0	<input type="checkbox"/>	<input type="checkbox"/>
0.0.0.0	0.0.0.0	<input type="checkbox"/>	<input type="checkbox"/>
0.0.0.0	0.0.0.0	<input type="checkbox"/>	<input type="checkbox"/>

User Passwords

User Name	Password
Read Only:	
Read Only + Outputs:	
Read and Write:	

HTTPS Server Certificate files

Name	Value
Type:	SSLCertificateFile
Description:	Public key certificate file, ext. *.crt
Filename:	*.crt
Import file:	Vybrat soubor Soubor nevybrán Upload
Edit File:	Delete File
Type:	SSLCertificateKeyFile
Description:	Secret key file, ext. *.key
Filename:	*.key
Import file:	Vybrat soubor Soubor nevybrán Upload
Edit File:	Delete File
Type:	SSLCACertificateFile
Description:	CA certificate file, ext. *.pem
Filename:	*.pem
Import file:	Vybrat soubor Soubor nevybrán Upload
Edit File:	Delete File

Generate a private SSL key and selfsigned certificate for closed networks or testing purposes. The generated certificate is selfsigned and will be displayed as untrusted. Please add the certificate to the list of exceptions or use a certificate signed by a trusted certification authority. Please note that the generated data will replace the SSLCertificateFile and the SSLCertificateKeyFile. Generating the key can take up to 10minutes. Do not restart the device and do not search for sensors. Otherwise the key generation will be interrupted.

Generate:

For more information try <http://www.hw-group.com/>

1 Filters for IP addresses which may access the device

2 Configuration of usernames and passwords for accessing the device

3 HTTPS certificates

Note: For more information, see the detailed web interface description (2nd half of the manual).

SNMP

Poseidon2 4002 SNMP

General SNMP Settings

Name	Value
SNMP Port:	161
SNMP Port Listener:	162
SNMP Version:	1

SNMP Access

Community	Read	Write
---- Disabled ----	<input checked="" type="checkbox"/>	<input type="checkbox"/>
---- Disabled ----	<input checked="" type="checkbox"/>	<input type="checkbox"/>

SNMP Trap Destinations

Destination	Community	IP Address	Port
A.	---- Disabled ----	192.168.1.39	162
B.	---- Disabled ----		
C.	---- Disabled ----		
D.	---- Disabled ----		
E.	---- Disabled ----		

SNMP Communities

Community

MIB II System Group

Name	Value
SysContact:	support@HWgroup.cz
SysName:	Poseidon2 4002
SysLocation:	

Version: 3.3.3

Apply Changes

- 1 Selects SNMP protocol versions
- 2 5 destinations for SNMP Traps

Note: For more information, see the detailed web interface description (2nd half of the manual).

Email

Poseidon2 4002 EMAIL

Email Settings

Name	Value
SMTP Server:	some.smtp.server [IP Address or DNS Name]
SMTP port:	25
Email Sender Address:	user@domain.com
Authentication:	<input type="checkbox"/>
Secure TLS mode:	<input type="checkbox"/>
Name/Password:	User login name /
Email Subject Text:	Subject_0

Email Destinations

Name	Value
Alarm Email Recipient:	To0@domain.com
Alarm Email Copy:	To1@domain.com
Alarm Email Copy:	To2@domain.com
Alarm Email Copy:	To3@domain.com
Alarm Email Copy:	To4@domain.com
Periodic Log Recipient:	To5@domain.com

Test Email

Name	Value
State:	

Send Test Email

Periodic Status Settings

Name	Value
Periodical Status:	<input type="checkbox"/> [minutes]
Alarm reminder:	<input type="checkbox"/> [minutes]

Version: 3.3.3

Apply Changes

- 1 Inserted at the beginning of the e-mail subject line
- 2 Up to 5 recipients of alarm e-mails
- 3 E-mail test result
- 4 Sends a test e-mail

- 1 IP address of the "HWg-SMS-GW" to use for sending text messages
- 2 Recipients' phone numbers

Note: For sending text messages, we recommend to use HWg-SMS-GW3: one central SMS gateway for all HW group devices in a single LAN.

- 1 Click to manually synchronize time with the specified server
- 2 Interval for logging measured values
- 3 Expected size of recorded data

Portal

Poseidon2 4002 PORTAL

Portal Message

Name	Value
Portal Enable:	<input type="checkbox"/>
Server Address:	www.sensdesk.com/portal.php
IP Port:	80 Default 80
User Name:	
Password:	
Current Push Timer:	0
Current Log Timer:	0
Current Check Timer:	0
Cur. Autopush Block Timer:	0
Retransmit number:	0
Manual Push:	Manual Push

Sensors autopush config

Name	ID	Current Value	Autopush
Sensor 240	61964	42.7 %RH	0.0
Sensor 241	55824	23.9 °C	0.0

Digital Inputs (DI) autopush config

Name	ID	Current Value	Autopush
Binary 1	1	0(Off)	<input type="checkbox"/>
Binary 2	2	0(Off)	<input type="checkbox"/>
Binary 3	3	0(Off)	<input type="checkbox"/>
Binary 4	4	0(Off)	<input type="checkbox"/>
Binary 5	5	0(Off)	<input type="checkbox"/>
Binary 6	6	0(Off)	<input type="checkbox"/>
Binary 7	7	0(Off)	<input type="checkbox"/>
Binary 8	8	0(Off)	<input type="checkbox"/>
Binary 9	9	0(Off)	<input type="checkbox"/>
Binary 10	10	0(Off)	<input type="checkbox"/>
Binary 11	11	0(Off)	<input type="checkbox"/>
Binary 12	12	0(Off)	<input type="checkbox"/>
Comm Monitor 1	123	0(Off)	<input type="checkbox"/>

Version: 3.3.3

Apply Changes

- 1 Message from the portal
- 2 Enables connection to the remote portal
- 3 Click to connect to the portal
- 4 AutoPush configuration

Configures the communication with the portal using the HWg-Push protocol. Poseidon2 is the active side and establishes the connection periodically and/or whenever a change in a sensor value exceeds the configured AutoPush value.

Connection parameters for the www.SensDesk.com portal are pre-filled.

AutoPush configuration

Poseidon2 connects to the portal and notifies a DI state change whenever the input state changes (in case of sensors, the change must exceed the configured AutoPush value).

This configuration only applies to the communication between Poseidon2 and the online portal. Local alarm values are configured in the portal.

For portal connection, check:

1. Correct **Gateway IP** address
2. **DNS server** in the network settings
3. Correct **Server Address** of the portal

MQTT

Poseidon2 4002 MQTT

MQTT Settings

Name	Value	Description
MQTT Enable:	<input type="checkbox"/>	Enable/Disable MQTT Client services.
Server:	iot.eclipse.org	[IP Address or DNS Name]
Port:	1883	Default 1883 or 8883 for SSL.
Username:		
Password:		
Secure SSL mode:	<input type="checkbox"/>	
Client ID:		
Publish Period:	60	
Topic Prefix Name:		

Sensors Topic

Name	ID	Publish	Topic Name = value
Sensor 240	61964	<input type="checkbox"/>	61964/Value = 42.0 %RH
		<input type="checkbox"/>	61964/State = 0
Sensor 241	55824	<input type="checkbox"/>	55824/Value = 24.1 °C
		<input type="checkbox"/>	55824/State = 0

Inputs Topic

Name	ID	Publish	Topic Name = value
Binary 1	1	<input type="checkbox"/>	1/Value = 0
		<input type="checkbox"/>	1/State = 0
Binary 2	2	<input type="checkbox"/>	2/Value = 0
		<input type="checkbox"/>	2/State = 0
Binary 3	3	<input type="checkbox"/>	3/Value = 0
		<input type="checkbox"/>	3/State = 0
Binary 4	4	<input type="checkbox"/>	4/Value = 0
		<input type="checkbox"/>	4/State = 0
Binary 5	5	<input type="checkbox"/>	5/Value = 0
		<input type="checkbox"/>	5/State = 0
Binary 6	6	<input type="checkbox"/>	6/Value = 0
		<input type="checkbox"/>	6/State = 0
Binary 7	7	<input type="checkbox"/>	7/Value = 0
		<input type="checkbox"/>	7/State = 0
Binary 8	8	<input type="checkbox"/>	8/Value = 0
		<input type="checkbox"/>	8/State = 0
Binary 9	9	<input type="checkbox"/>	9/Value = 0
		<input type="checkbox"/>	9/State = 0
Binary 10	10	<input type="checkbox"/>	10/Value = 0
		<input type="checkbox"/>	10/State = 0
Binary 11	11	<input type="checkbox"/>	11/Value = 0
		<input type="checkbox"/>	11/State = 0
Binary 12	12	<input type="checkbox"/>	12/Value = 0
		<input type="checkbox"/>	12/State = 0
Comm Monitor 1	123	<input type="checkbox"/>	123/Value = 0
		<input type="checkbox"/>	123/State = 0

Version: 3.3.3

Apply Changes

- 1 Enables connection to the remote broker
- 2 Enables SSL for MQTT
- 3 Selects the messages to send

Configures the communication of Poseidon2 unit with the MQTT broker. The device periodically establishes a connection to the broker, as defined by the Publish Period, and sends the messages that are selected in the **Publish** section.

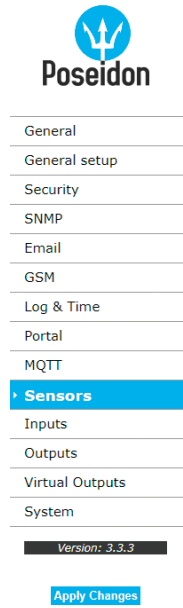

The screenshot shows the 'Sensors' configuration page for the Poseidon2 4002 device. The page has a blue header with the device name and 'SENSORS'. Below the header is a table with columns: Name, Safe Range, Hysteresis, Delay [s], SNMP Trap, Email, SMS, and Syslog. Two sensors are listed: Sensor 240 and Sensor 241. Sensor 240 has a value of 41.4 %RH, and Sensor 241 has a value of 25.6 °C. There are numbered callouts 1 through 7 pointing to various configuration fields. At the bottom, there are buttons for 'Find 1Wire + RS485 sensors' and 'Find 1Wire sensors', and an 'Apply Changes' button.

- 1 Sensor name will be shown in e-mails, text messages, or SNMP traps.
- 2 Range of allowed values. If exceeded, alarm is signaled.
- 3 Sends a **SNMP Trap** if the "Safe Range" for this sensor is exceeded.
- 4 Sends an **e-mail** if the "Safe Range" for this sensor is exceeded.
- 5 Sends a **text message (SMS)** if the "Safe Range" for this sensor is exceeded.
- 6 Sends a **SYSDLOG** message if the "Safe Range" for this sensor is exceeded.
- 7 Scans connected sensors and displays detected sensors.

After connecting sensors or changing RJ11 connections, sensors need to be detected again.

To avoid numerous false alerts (by e-mail or SMS) whenever the reading fluctuates around the threshold, you can use:

1) **Hysteresis Idle Range** – tolerance band around the "Safe Range". Prevents multiple alarm alerts.

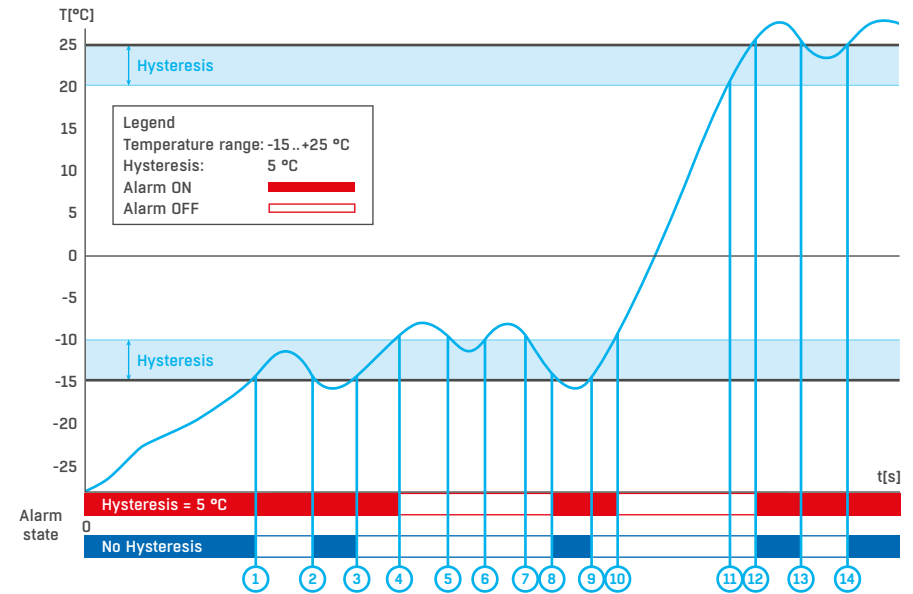

2) **Delay [s]** – delays the information about alarm beginning and alarm end by a specified time. Can be used for dry contacts, too.

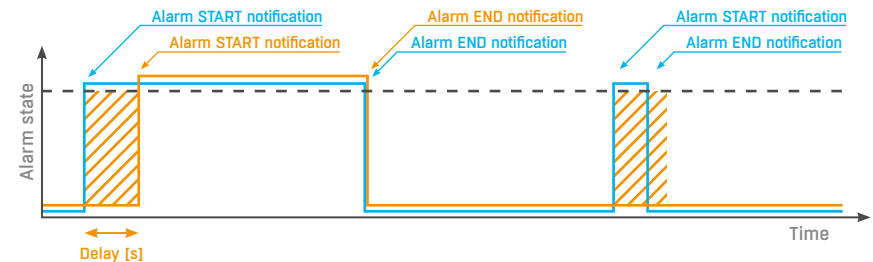

Alarm status notification based on a Delay value:

- Blue: Delay = 0
- Yellow: Delay is non-zero

CAUTION: Configuration changes must be confirmed by clicking the Apply Changes button.

Inputs

Name	ID	Current Value	Alarm State	Delay[s]	SNMP Trap	Email	SMS	Syslog
Binary 1	1	0(Off)	Disabled	0	<input type="checkbox"/>	<input type="checkbox"/>	<input type="checkbox"/>	<input type="checkbox"/>
Binary 2	2	0(Off)	Disabled	0	<input type="checkbox"/>	<input type="checkbox"/>	<input type="checkbox"/>	<input type="checkbox"/>
Binary 3	3	0(Off)	Disabled	0	<input type="checkbox"/>	<input type="checkbox"/>	<input type="checkbox"/>	<input type="checkbox"/>
Binary 4	4	0(Off)	Disabled	0	<input type="checkbox"/>	<input type="checkbox"/>	<input type="checkbox"/>	<input type="checkbox"/>
Binary 5	5	0(Off)	Disabled	0	<input type="checkbox"/>	<input type="checkbox"/>	<input type="checkbox"/>	<input type="checkbox"/>
Binary 6	6	0(Off)	Disabled	0	<input type="checkbox"/>	<input type="checkbox"/>	<input type="checkbox"/>	<input type="checkbox"/>
Binary 7	7	0(Off)	Disabled	0	<input type="checkbox"/>	<input type="checkbox"/>	<input type="checkbox"/>	<input type="checkbox"/>
Binary 8	8	0(Off)	Disabled	0	<input type="checkbox"/>	<input type="checkbox"/>	<input type="checkbox"/>	<input type="checkbox"/>
Binary 9	9	0(Off)	Disabled	0	<input type="checkbox"/>	<input type="checkbox"/>	<input type="checkbox"/>	<input type="checkbox"/>
Binary 10	10	0(Off)	Disabled	0	<input type="checkbox"/>	<input type="checkbox"/>	<input type="checkbox"/>	<input type="checkbox"/>
Binary 11	11	0(Off)	Disabled	0	<input type="checkbox"/>	<input type="checkbox"/>	<input type="checkbox"/>	<input type="checkbox"/>
Binary 12	12	0(Off)	Disabled	0	<input type="checkbox"/>	<input type="checkbox"/>	<input type="checkbox"/>	<input type="checkbox"/>
Comm Monitor 1	123	0(Off)	Disabled	0	<input type="checkbox"/>	<input type="checkbox"/>	<input type="checkbox"/>	<input type="checkbox"/>

- 1 Enter a DI name to show in e-mails, text messages or SNMP traps
- 2 Alarm state of a contact:
 - Active if On alarm when the contact is closed (1 = On)
 - Active if Off alarm when the contact is open (0 = Off)
 - Disabled no alarm
- 3 Reaction to DI inputs:
 - Disabled
 - Send a SNMP Trap
 - Send an e-mail
 - Send a SMS
 - Send a SYSLOG message

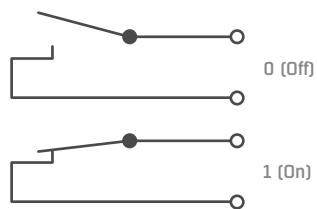

Connecting the inputs

Frequently asked questions:

- Poseidon2 informs about alarm activation and deactivation for each Digital Input and / or sensor.
- E-mail format cannot be changed but sensors may have custom names.
- Yellow background of the line with a sensor or an input means that the safe range is exceeded but alarm notification is off.

CAUTION: Configuration changes must be confirmed by clicking the Apply Changes button.

Outputs

ID	Current Value	Basic parameters	Output Control
151	0(Off)	Name: BinOut 1 ON (Closed) Name: On OFF (Open) Name: Off Pulse Timer: 0 Sec	Manual (selected) LocalCondition Change to On
152	0(Off)	Name: BinOut 2 ON (Closed) Name: On OFF (Open) Name: Off Pulse Timer: 0 Sec	Manual LocalCondition Change to On
153	0(Off)	Name: BinOut 3 ON (Closed) Name: On OFF (Open) Name: Off Pulse Timer: 0 Sec	Manual LocalCondition Change to On
154	0(Off)	Name: BinOut 4 ON (Closed) Name: On OFF (Open) Name: Off Pulse Timer: 0 Sec	Manual LocalCondition Change to On

- 1 Choose the output control mode:
 - Manual mode:** Output controlled over the WEB or M2M protocols
 - Local Condition mode:** Controls the output according to the specified sensor
- 2 Enter a DO name to show in e-mails, text messages or SNMP traps
- 3 Pulse output timer [s]. By default, Pulse Timer = 0 for standard output behavior

Pulse Timer – when set, the output is activated only for a specified duration. Pulse Timer = 0 disables this function. For details, see the *WEB interface manual*.

Output Control mode:

- Manual** – the output can be controlled using the web interface or externally using M2M protocols. The output cannot be used in “thermostat” mode (local condition).
- Local Condition** – the output cannot be controlled over the Web, it is controlled by a local condition. The output is read-only for all M2M protocols. Hysteresis in the sensor settings is used. In the **Local Condition** mode, outputs cannot be controlled over the WEB or using M2M protocols.
 - On if any alarm – the output is active if at least one input or sensor is in alarm.
 - On if value equal to Trigger – the output is active if the selected sensor reading is equal to the “Target Value”.
 - On if value higher than Trigger – the output is active if the selected sensor reading is greater than the “Target Value”.
 - On if value lower than Trigger – the output is active if the selected sensor reading is less than the “Target Value”.
 - On if Alarm On – the output is active when a particular sensor or input is in the Alarm state.
 - Dependent On – sensor / input to which the condition applies.

Virtual outputs

Poseidon2 4002 VIRTUAL OUTPUTS

Virtual Digital Outputs (VDO)

ID	Virtual Type	Basic parameters
1151	Network Output	Name: VirtBinOut 1 Remote device address: 192.168.100.10 Port: 80 Remote port ID: 151 Username: Password: Status: Disabled
1152	Network Output	Name: VirtBinOut 2 Remote device address: 192.168.200.5 Port: 80 Remote port ID: 153 Username: admin Password: Status: Disabled
1153	Disabled	Name: VirtBinOut 3 Remote device address: Port: 80 Remote port ID: 0 Username: Password: Status: Disabled
1154	Disabled	Name: VirtBinOut 4 Remote device address: Port: 80 Remote port ID: 0 Username: Password: Status: Disabled
1155	Disabled	Name: VirtBinOut 5 Remote device address: Port: 80 Remote port ID: 0 Username: Password: Status: Disabled

Version: 3.3.3

Apply Changes

- 1 Enter a VDO name to show in e-mails, text messages or SNMP traps.
- 2 IP Address and HTTP Port of the remote Poseidon2 or Damocles2 where the outputs will be controlled
- 3 Remote output ID
- 4 VDO type
 - Disabled – inactive
 - Network Output – accessible over HTTP (XML)

Virtual outputs of Poseidon2 and Damocles2 units allow the use of outputs of other Poseidon2 or Damocles2 units (Box2Box). It is similar to the previous mode that was based on SNMP Traps. However, Virtual Outputs use periodical (every 60 s), secure and more reliable communication over the TCP/IP protocol and support all the functions, conditions and properties as the physical outputs.

System

Poseidon2 4002 SYSTEM

Communication Monitor

Name	Value	Description
Modbus:	<input type="checkbox"/>	Monitors communication with a device based on all selected protocols. Virtual Input "Comm Monitor 1(123)" sets to 0 in case there was any traffic using all selected protocols within the defined time.
XML/HTTP:	<input type="checkbox"/>	
SNMP:	<input type="checkbox"/>	
Time:	0 [s]	

Configuration

Name	Value	Description
Load Configuration:	Vybrat soubor	Soubor nevybran
Save Configuration:		

System

Name	Value	Description
Product Name:	Poseidon2 model 4002	
Serial Number:	6005711389	
MAC Address:	00:0A:59:04:A1:4E	
Build:	3396	
Compiled time:	Aug 17 2017, 12:36:52	
Uptime:	0days,22hours,47minutes	Restart Device
Factory Default:		Set Default Config
Device FirmWare:	3.3.3	Update FW

Version: 3.3.3

Apply Changes

For more information try <http://www.hw-group.com/>

- 1 Restores factory defaults
- 2 Uploads new firmware from the PC

Communication Monitor

This function is useful e.g. to send a warning e-mail whenever Poseidon2 ceases to be periodically monitored over SNMP or SCADA.

This function controls a virtual Digital Input that is available in *Inputs* as "Com Monitor 1" with the ID of 123. If no communication took place in the specified time using the selected protocols, it sets "Com Monitor 1" = 0 (Off).

When three protocols are enabled (checked), all three must function in the "OK" status.

Configuration

- Upload – restore the configuration from the PC to the device.
- Download – save the configuration from the device to the PC.

CAUTION: Configuration changes must be confirmed by clicking the Apply Changes button.

Connecting the sensors

1-Wire Bus (RJ11) sensors

- Connect the sensor before powering up the Poseidon2 – **the connector must click in**.
- **Max. distance per active port is 60 m.**
- Sensors can be daisy chained.
- Sensors can be also connected using a star topology with the T-Box (TBox2) hub.
- If there is a change in the connected sensors, the sensors must be detected again (WWW interface > Sensors > **Autodetect sensors**).

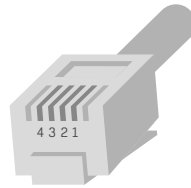

RJ11 (4P6C)

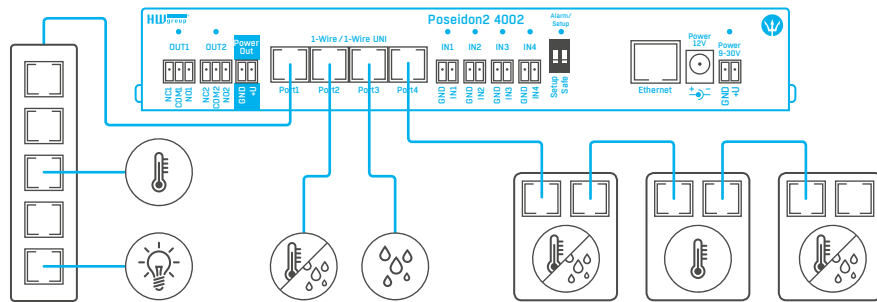

Maximum total length of all cables connected to a single port is 60 m.

RS-485 (RJ45) sensors

Industrial bus for connecting sensors over longer distances.

- Connect the sensors before powering up the unit.
- Sensors can be daisy chained, or connected to a virtual star using the “S-Hub” unit.
- **Terminate the RS485 line** with a 120Ω to 470Ω terminator. Some sensors contain a built-in, jumper- or DIP-controlled terminator. See the sensor manual.
- Check or set the sensor address. Each sensor on the RS-485 bus must have **a unique address**. The address (ID) is expressed as a letter (A..Z/a..z) or a number (65..122). The number corresponds to the ASCII code of the given letter: A=65, Z=90, a=97, z=122. For details about setting the address, see the sensor manual.
- If there is a change in the connected sensors, the sensors must be detected again (WWW interface > Sensors > **Autodetect sensors**).

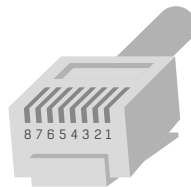

RJ45 (8P8C)

Sensors are shipped with non-conflicting addresses whenever possible. The preconfigured address is written on the label.

Note: A particular sensor is identified by its RS-485 address. Sensors with the same address can be swapped without the need for a new detection.

Common features of the Poseidon2 family

Displayed readings

- Poseidon2 displays current readings from all connected sensors.
- Dry contact inputs are scanned approximately every 20ms and feature pulse counters. In order to signal an alarm, the respective digital input must remain in the Alarm state for at least 900ms.
- Values from all sensors on both buses (RS-485 and 1W bus) are read in a single loop that repeats once per second; however, the actual time needed to read all sensors may vary from 1 to 30 seconds.
- All values are in the “integer/10” format. The range is ±999.9.
- **A value of 999.9** is out of range for all supported sensors and indicates that the sensor was not found.
 - If you have disconnected or replaced a sensor, run sensor autodetection, or remove the sensor from the list.
 - When the Poseidon unit is overloaded with network requests (as is sometimes the case, for example, with our public online demo), -999.9 can sometimes appear even though the sensor works properly. This is due to limited computing performance of the unit. Try to reduce the number of direct requests.
- Measurement units are assigned to values automatically according to the detected sensor type. Supported units include:
 - Temperature: °C, °K, °F (please note that Safe Range thresholds can be set in °C only)
 - Humidity: %RH
 - Voltage: V, current: A or mA
 - Other units: %, and more...

Input / sensor in alarm state

- Alarm state can be set independently for every input (contact)/ sensor.
- For a sensor, “Alarm” occurs whenever the reading is outside of the specified Safe Range, as long as alarm alerting is enabled for at least one notification method (SNMP / e-mail & SMS).
- **Response to a sensor being disconnected:**
 - -999.9 is displayed.
 - The value evaluates as an “Alarm” (reading out of the specified Safe Range). If alarm alerting is enabled for the given sensor, e-mail or SNMP trap is sent.

Calibration

Each sensor can be calibrated by specifying a linear offset. The calibration value can be set using XML. To set the calibration value, use the Calibrator utility (available for download at <http://hw-group.us/product-version/hwg-calibrator>).

- Calibration value = +3 → sensor measures 0.5°C → Poseidon2 shows +3.5°C.
- Calibration value = -3 → sensor measures 0.5°C → Poseidon2 shows -2.5°C.
- Calibration value = -10 → sensor measures 27% RH → Poseidon2 shows 17% RH.

Sensor hysteresis

The Hysteresis setting defines a tolerance band for alarm alerts. This feature prevents multiple alarm alerts if the reading oscillates around the specified threshold. See the graph for an explanation.

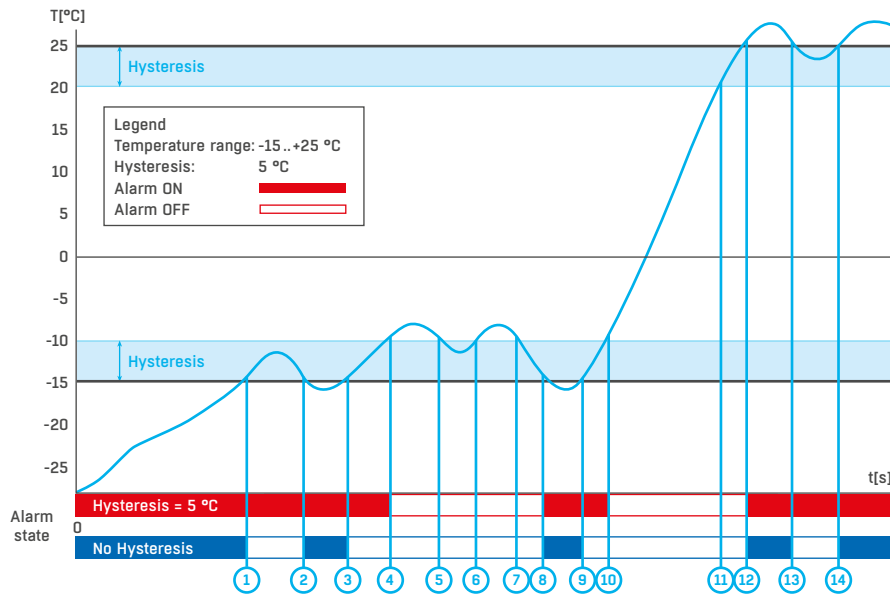

Without a hysteresis of 5°C, the alarm raised at point 8 would end at point 9. With the hysteresis function, the alarm continues until the temperature rises above the tolerance band (point 10), that is, 5°C + (-15°C) = -10°C.

- **Hysteresis = 5 °C:** The unit sends **3 e-mails (SMS)**
Alarm at points **0..4, 8..10, 12 and after**
- **No hysteresis = 0 °C:** The unit sends **8 e-mails (SMS)**
Alarm at points **0..1, 2..3, 8..9, 12..13, 14 and after**

Supported interfaces (in detail)

Connectors and connections



Power connector

DB9M: RS-232			
	1	5	
	6	9	
1	-	-	Not used
2	RxD	←	Receive Data
3	TxD	→	Transmit Data
4	DTR	→	Data Terminal Ready
5	GND	—	System Ground
6	DSR	←	Data Set Ready
7	RTS	→	Request to Send
8	CTS	←	Clear to Send
9	-	-	Not used

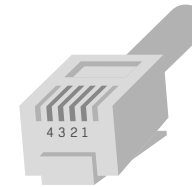

RJ11 (4P6C)

RJ11: 1-Wire		
	+5V	Power
1	-	Not used
2	Data	Transmit Data
3	GND	Ground
4	+5V	Power
	-	Not used

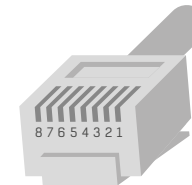

RJ45 (8P8C)

RJ45: RS-485		
1		Not used
2		Not used
3		485 B return
4		RS-485
5		
6		485 A return
7		Ground
8		Power

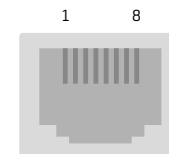

Dry contact inputs

Dry (voltage-free) contacts can be connected to the terminals. For example door contacts. The inputs are electrically connected to the power supply.

- Unconnected inputs read as “**0 (Off)**”.
- Activated inputs (closed contacts) read as “**1 (On)**”, resistance against the Common pin must not exceed 500Ω.
- Poseidon2 inputs feature pulse counters; this can be used for example to read energy consumption from meters with a pulse output (SO). Counters are incremented whenever the input is closed. The pulse must be longer than 20ms to be registered.

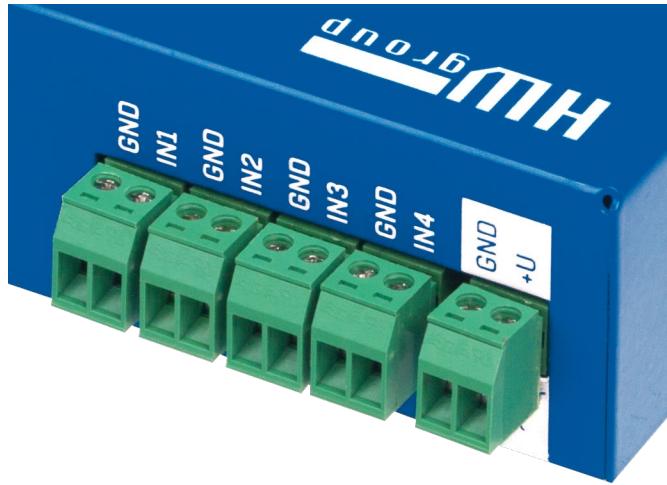

Specifications:

- **Maximum cable length:** 50 m.
- **Supported sensors:** any contact without external voltage (dry contact).
- **Alarm settings for each DI:**
 - Alarm inactive.
 - Alarm when the contact is closed.
 - Alarm when the contact is open.
- **Possible Alarm responses:** (Common setting for all inputs).
 - No response.
 - Alarm alert sent as a SNMP trap.
 - Alarm alert sent by e-mail or text message (SMS).
 - Alarm alert sent as a SNMP trap as well as by e-mail or SMS.
- **Input polling period for alarms:** approx. 900 ms.
- **Input polling period for pulse counting:** approx. 20 ms.
- **Range of sensor IDs:** inputs use ID addresses from 1 to 9.
- **Sensor names:** sensors can be named using up to 12 characters.
- **Disconnected sensor detection:** none, disconnected sensor reads as “**0 (Off)**”.

RJ11 – 1-Wire bus

Digital bus used by Dallas Semiconductors. Each sensor has a unique ID.

We recommend to keep the total wiring length under **60 m**, although functionality has been achieved over tens to hundreds of meters in experimental settings.

If the wiring connected to one connector of the Poseidon2 unit is longer than approximately 60 m, we **cannot guarantee error-free operation**, as it greatly depends on the actual wiring implementation, topology and environment.

Active / Passive 1W port

An **active port** is the RJ11 jack at the Poseidon2 unit. It supports the full maximum cable length and provides power for all 1-Wire UNI / 1-Wire sensors.

When a sensor connected to one active port is moved to another one, it will appear disconnected. It is necessary to run the sensor auto-detection again.

A **passive port** is a RJ11 jack at a T-Hub or a RJ11 jack at a sensor (when daisy chaining). It cannot guarantee full cable length support and power for subsequent sensors. Sufficient power can be ensured with a 1-Wire hub Power unit.

1-Wire UNI (RJ11)

1-Wire **UNI** is a software extension of the 1-Wire bus.

- **1-Wire UNI sensors:**
 - Illumination sensor
 - 4–20 mA current sensor
 - 0–60 V (–48 V DC) voltage sensor
 - 0–30 A AC current sensor
 - Various other sensors – http://www.hw-group.com/products/sensors/index_en.html
- **Maximum wiring length:** 60 m total length per active RJ11 port.
Note: The maximum length can be reduced when certain 1-Wire UNI sensors or multiple RJ11 male-female connectors are used.
- **Power to sensors:** 5 V / 20 mA from the RJ11 jack (can be boosted by a “1-Wire hub Power”).

Other parameters are identical to 1-Wire.

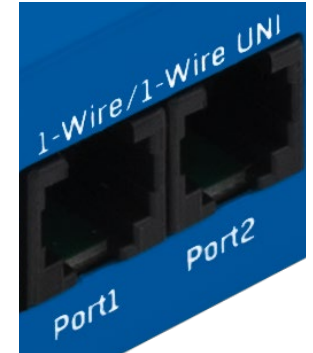

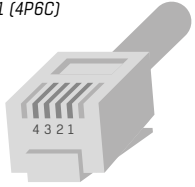
RJ11		
RJ11 (4P6C)		
		
1	-	Not used
2	Data	Transmit Data
3	GND	Ground
4	+5V	Power

1-Wire (UNI) bus

- **Supported sensors:** only sensors supplied by HW group.
- **1-Wire UNI:** the “UNI” software extension enables support for other than temperature and humidity sensors.
- **Communication cable:** 4-wire telephony cable.
- **Polling period:** 800 ms to 10 s.
- **Sensor address assignment:** automatic, each sensor has a unique address.
- **Disconnected sensor detection:** yes, disconnected sensor reads as “-999.9”.
- **Alarm if sensor is disconnected:** if the sensor is set to alarm whenever its reading is outside of the safe range, disconnection triggers the alarm.

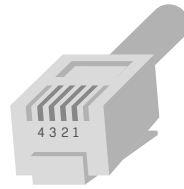

RJ11 (4P6C)

1-Wire bus accessories

- **Poseidon T-Box** – 5-way hub for 1-Wire/1-Wire UNI sensors
- **1-Wire hub Power** – 8-way hub + power booster for 1-Wire/1-Wire UNI sensors
- **Poseidon T-Box2** – 2-way hub for 1-Wire/1-Wire UNI sensors

Remember: All 1-Wire bus sensors have their unique serial numbers. These are stored with sensor names during autodetection and expressed using the sensor IDs. If you change the sensors on the bus, you must re-run **Autodetection** in the Flash SETUP.

Special accessories for the 1-Wire bus

- **1-Wire hub Power** – power booster + hub for 8 sensors
 - **1× input:** 1-Wire bus
 - **1× input:** 12 V DC power
 - **8× output:** 1-Wire bus
- **Compatible with 1-Wire** and **1-Wire UNI** bus

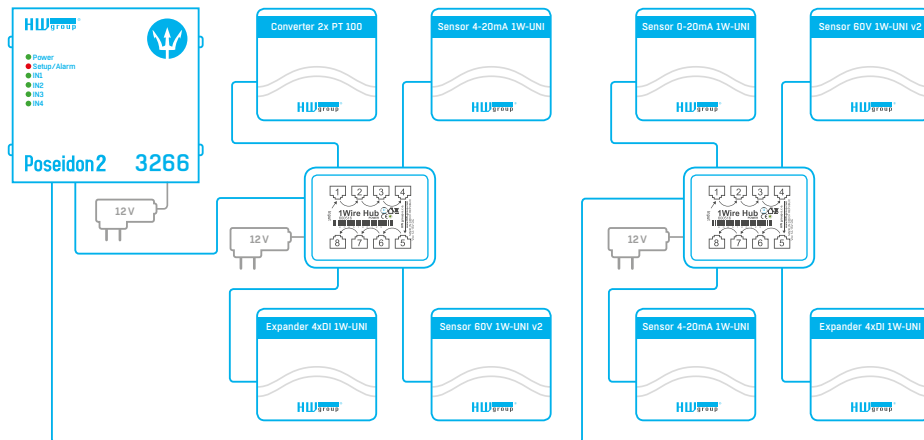

- **Poseidon T-Box2** – hub for 2 sensors
 - **Cable length:** 1m
 - **Maximum number of connected sensors:** 2
 - **Connectors:** RJ11
 - **Bus type:** 1-Wire bus
- **Poseidon T-Box** – hub for 5 sensors
 - **Cable length:** 10 cm
 - **Maximum number of connected sensors:** 5
 - **Connectors:** RJ11
 - **Bus type:** 1-Wire bus
- **Poseidon Spider** – bridges 1-Wire bus to RS-485
 - The Spider unit connects to Poseidon2 over the RS-485 bus.
 - 4 sensors for the 1-Wire bus can be connected to the Spider unit.
 - Spider ONLY supports temperature, humidity, and dry contact state sensors.
 - Each sensor is connected to a separate connector and may be located up to 25m away.
 - Maximum number of connected sensors: 4× 1-Wire.
 - Sensor types: 1-Wire bus (1-Wire) (does NOT support 1-Wire UNI).
 - Connects to: RS-485.

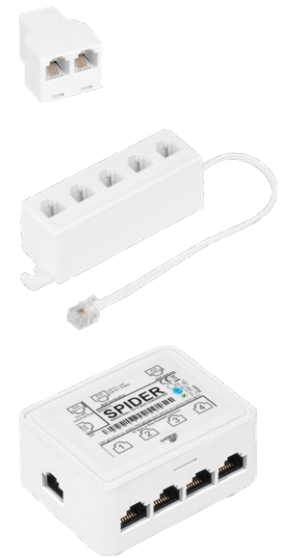

Caution: The Poseidon2 unit warranty explicitly excludes failures caused by connecting sensors made by other manufacturers or with excessively long wiring.

RJ45 – RS-485

The RS-485 bus can be used to connect up to 31 sensors over up to 1000 m, even in industrial environments. For convenience and ease of use, TP cables and RJ45 modular jacks are used to wire the RS485 industrial bus.

The **RS-485 bus** uses the **blue pair** of wires (pins 4 and 5), labeled A and B. The **brown pair** (pins 7, 8) carries 12V to **power** the sensors.

If you use the S-Hub unit and the B-Cable module, the **green pair** of wires (pins 3, 6) is used for the **return RS-485 connection**. The green pair of wires is not connected at the Poseidon2 4002 unit.

- **Maximum wiring length:** up to 1000 m in total.
- **Supported sensors:** temperature, humidity, current, voltage and other sensors.
- **Number of sensors on the RS-485 bus:** Up to 31 physical sensors.

Port 1 – RJ45		
	1	8
1		Not used
2		Not used
3		485 B return
4		B (-)
5		A (+)
6		485 A return
7		GND
8		+12V Power

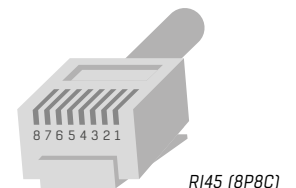

RJ45 (8P8C)

- **Power:** 12 V / 120 mA, available at the RJ45 jack. Power supplied by the bus is sufficient for up to 3 external sensors, an **S-Hub** can be added to power more sensors.
- **Communication cable:** UTP, in some cases 4-wire phone cable.
- **Alarm settings:** checking the reading against its Safe Range.
- **Polling period:** 800 ms to 10 s (depending on the number of sensors, 10 seconds for 41 sensors).
- **Sensor address assignment:** manual, each sensor must have a unique address (see the *Manual for the particular sensor*).
- **Range of sensor IDs:** sensors use IDs from 48 to 122, the address corresponds to the ASCII code of 0..9, A..Z, a..z characters.
- **Disconnected sensor detection:** yes, disconnected sensor reads as **"-999.9"**.
- **Alarm if sensor is disconnected:** if the sensor is set to alarm whenever its reading is outside of the safe range, disconnection triggers the alarm.

General RS-485 characteristics

- Maximum wiring length 1000 m.
- Up to 32 devices on the bus (Poseidon2 unit + 31 sensors).
- High resistance to noise in industrial environments.
- Daisy chain topology is necessary (as opposed to star topology).
- Each device must have a unique address.
- Wire polarity must be respected.
- Line must be terminated at the beginning and at the end.

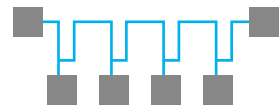

Line (daisy chain) RS-485 topology

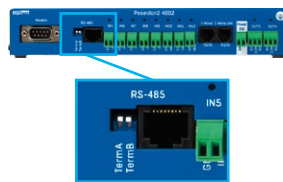

RS-485 termination at the Poseidon2 side

Poseidon2 4002 includes two DIP switches, labeled TermA and TermB, to activate RS-485 termination.

Poseidon2 4002 at the beginning of the RS-485 bus

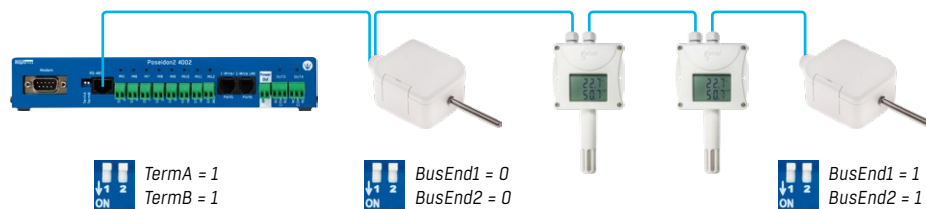

Poseidon2 4002 in the middle of the RS-485 line

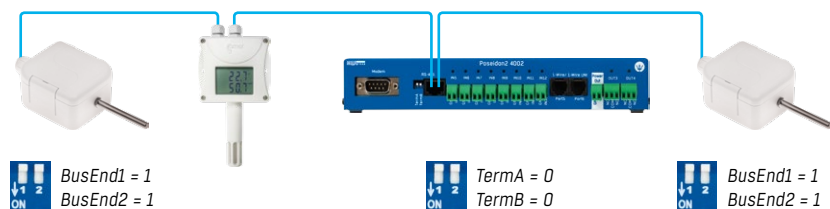

RS-485 termination

The RS-485 bus must be terminated at its end. The following options are available:

- **DIP switch or jumper** in certain sensors (jumper labeled TERM, TERMINATOR or BusEnd) – for example Temp-485 or HTemp-485.
- If the **B-Cable adaptor** is used, set the switches to the "LAST" configuration.
- **External resistor** for sensors without a jumper or a DIP switch (Temp-485-Pt100). Terminate the end of the RS-485 bus at the last sensor with an external resistor (connected between the A and B terminals of the last sensor).

The resistance of this resistor should be 120Ω. For a short wiring, up to 470Ω can be used to reduce the current consumption of the sensors.

Note: A disadvantage is that it is necessary to have **a wiring topology with a single beginning and a single, terminated end**, as opposed to the popular star topology with a single interconnection point.

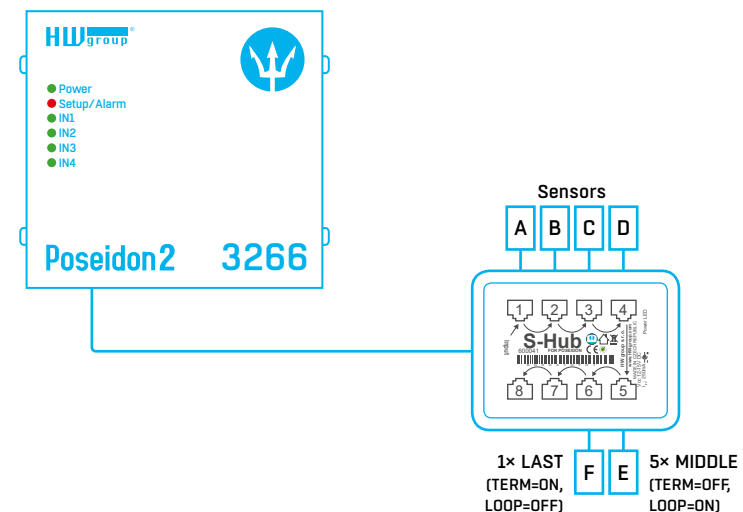

Sensor RJ45 MIDDLE cable

RS-485 cable, 0.5m, RJ45/4 pins. Connects 4 terminals (A, B, +, -) to a RJ45 jack (3 pairs).

This cable is used to connect all sensors except for the last one in the chain.

Sensors connected with this cable **must not terminate** the RS-485 bus.

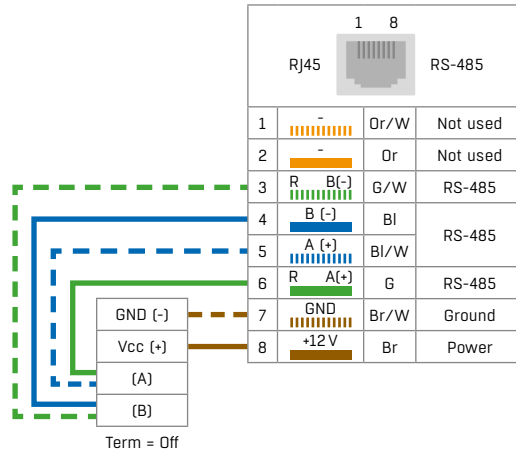

Sensor RJ45 LAST cable

RS-485 cable, 0.5m, RJ45/4 pins. Connects 4 terminals (A, B, +, -) to a RJ45 jack (2 pairs only).

This cable is used to connect the last sensor in the chain.

The sensor connected with this cable **must terminate** the RS-485 bus in one of the following ways:

- External 120Ω termination resistor.
- Jumper or DIP switch at the sensor set to TERM=ON.
- For other options, see the sensor manual.

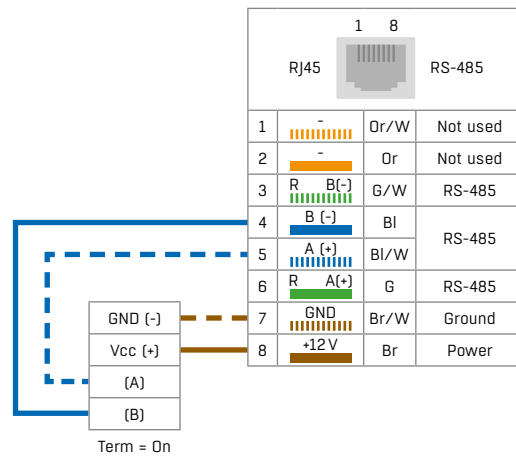

Poseidon Spider

A converter to connect four 1-Wire bus sensors to the RS-485 bus. Each 1-Wire bus sensor connects to a separate connector. The Spider allows to connect Poseidon2 with 1-Wire sensors at a greater distance (up to 1000 m between the Poseidon2 and Poseidon Spider, as defined by the RS-485 bus specification).



S-Hub – 8× RJ45 TP hub.

The S-Hub unit with one input and 8 output ports is used to connect up to eight RS-485 sensors with TP cables.

- Makes it possible to connect sensors in a star topology (sensors must be connected using TP cables).
- Simpler and faster connection of sensors.
- Makes expanding an installation easier.
- Easier way of powering the sensors. A standard power adapter connects directly to the S-Hub unit.

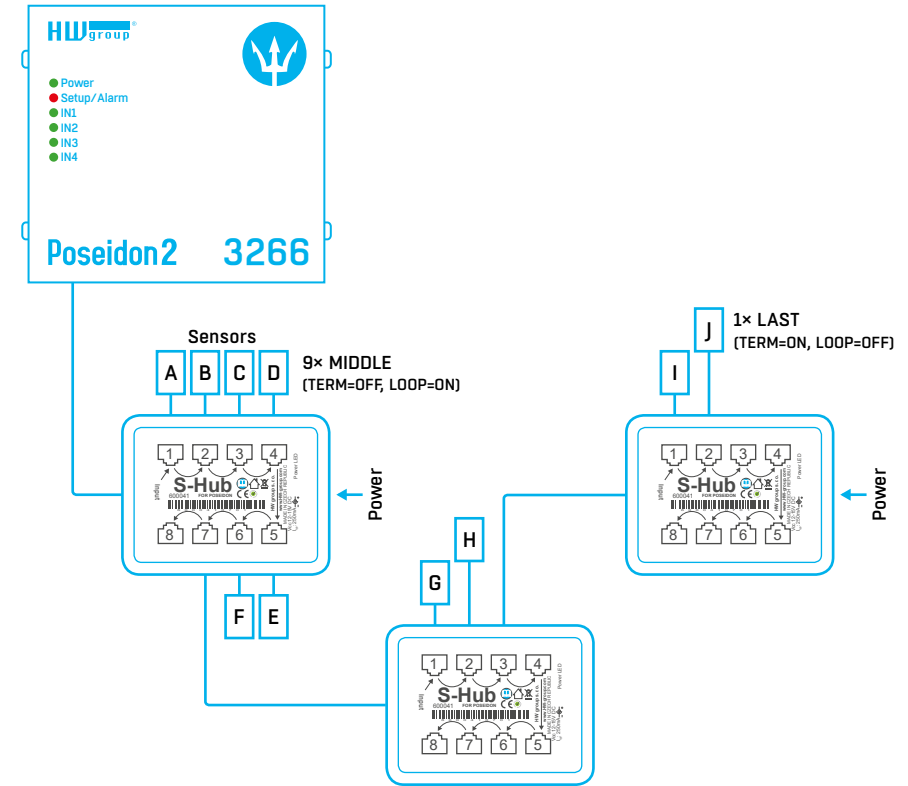

Note: It is possible to mix the star / daisy chain topologies with S-Hub, see the examples in the following chapter.

RS-485 bus wiring example

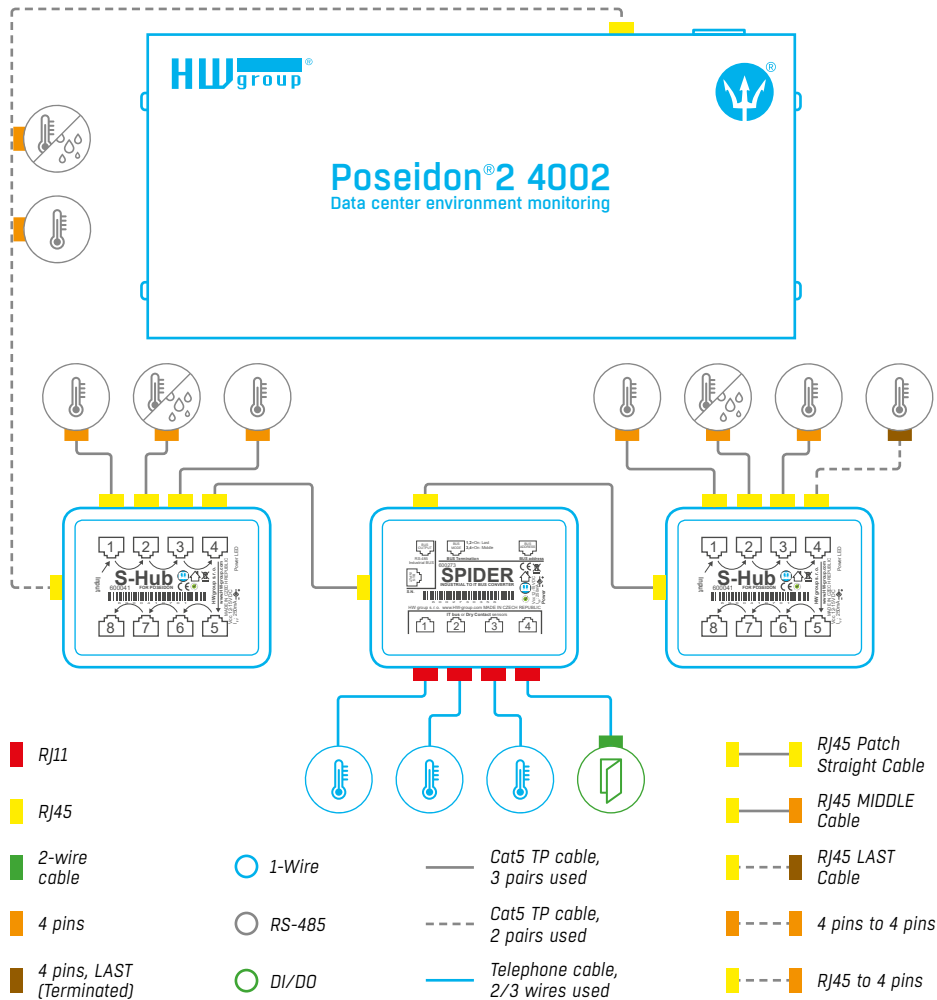

- The bus leads via a 4-wire connection from a Poseidon2 4002 unit to two daisy chained sensors, **Temp-485** and **HTemp-485**. Two twisted pairs are used for the connection.
- An **S-Hub** unit is daisy chained via the RJ45 jack to the second **HTemp-485** sensor using a 4-wire connection. The brown pair carries power, the blue pair is used for data.
- **Temp-485** and **HTemp-485** sensors are connected to S-Hub connectors 1 through 3 using 6-wire connections (brown pair for power, blue pair leads the bus to the device, green pair back from the device).
- Connector 4 of the first **S-Hub** unit is used to connect a **Spider** converter with a patch cable. The Spider is used to connect three **Temp-1Wire 10m** sensors and one door contact (the contact is connected to the blue RJ45 pair).

- The second **S-Hub** unit is connected with a patch cable to the **Spider** output.
- **Temp-485** and **HTemp-485** sensors are connected to S-Hub connectors 1 through 3 using 6-wire connections (brown pair for power, blue pair leads the bus to the device, green pair back from the device).
- Connector 4 connects a **Temp-485** sensor with a 4-wire connection (brown pair to power the sensor, blue pair for the A/B signals of the bus). The **Temp-485** sensor is configured to terminate the bus using the **TERM** jumper.

User interface

HWg Config

HWg Config is a freeware utility for assigning IP addresses and changing network settings over the Ethernet.

- Windows and Linux version.
- IP address is assigned to a product with a specific MAC address.
- No installation is necessary, simply run the EXE file.
- Provides a clear overview of device names and parameters.

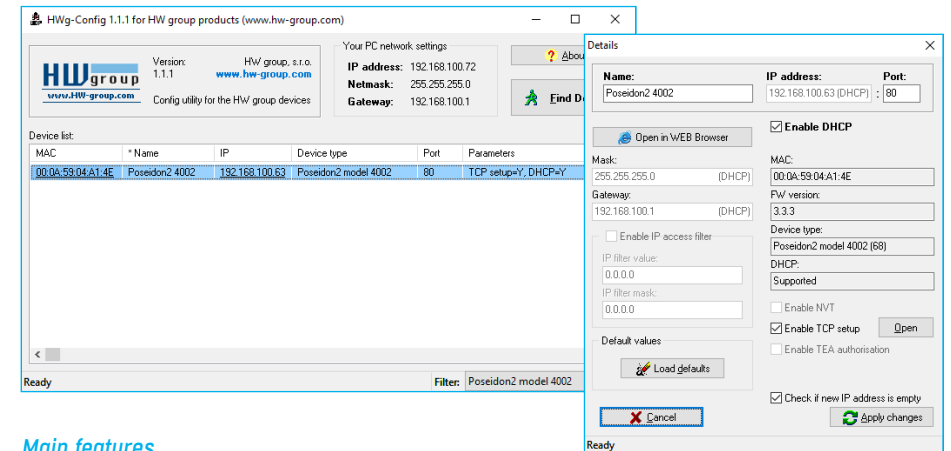

Main features

- Concise graphical environment.
- Device name, type, MAC address, IP address and communication port is displayed after a device is found.
- Compatible with all HW group products (Poseidon2, Damocles2, PortBox, PortStore, I/O Controller, IP relay and other product families).
- Windows and Linux versions available.
- Displays current network settings of your computer.
- Checks if the IP address is in use before assigning it.
- Single-click access to the device web page.
- Ability to open a Telnet session for TCP Setup.
- Ability to restore "factory-default" settings.

WEB interface

Main communication interface.

Poseidon2 offers a simple and user-friendly graphical WWW interface. Besides displaying current readings, the interface provides access to complete device configuration and management, including network settings, sensor configuration and alarm responses (SNMP traps).

To access the web interface, enter the Poseidon2 IP address into the URL field of your browser.

General

The main page with the overview of sensor and input readings automatically reloads at configurable intervals (by default every 10 seconds, can be changed easily).

Name	ID	Current Value	Safe Range	Hysteresis	Alarm Alert
Sensor 240	81064	27.1 °C	20.0 .. 30.0	0.0	SNMP trap
Sensor 241	55824	22.5 °C	10.0 .. 60.0	0.0	Disabled

Name	ID	Current Value	Alarm Alert
Binary 1	1	1 (On)	Active if on
Binary 2	2	0 (Off)	Disabled
Binary 3	3	0 (Off)	Disabled
Binary 4	4	0 (Off)	Disabled
Binary 5	5	1 (On)	Active if on
Binary 6	6	0 (Off)	Disabled
Binary 7	7	0 (Off)	Disabled
Binary 8	8	0 (Off)	Disabled
Binary 9	9	0 (Off)	Disabled
Binary 10	10	0 (Off)	Disabled
Binary 11	11	0 (Off)	Disabled
Binary 12	12	0 (Off)	Disabled
Comm Monitor 1	123	0 (Off)	Disabled

Name	ID	Current Value	Mode
BinOut 1	151	0 (Off)	Manual
BinOut 2	152	0 (Off)	Manual
BinOut 3	153	0 (Off)	Manual
BinOut 4	154	0 (Off)	Manual

Sensors

The Sensors table displays information (valid at the time of the last refresh) about detected and activated sensors, including their states.

- **Name** – textual name of the input, assigned by user at the **Sensors** tab.
- **ID** – 16-bit ID of the sensor, unique within a particular device.
- **Current Value** – current sensor reading, including the measurement unit.
Note: *If a sensor is not connected, -999.9 is displayed.*
- **Safe Range** – as long as the reading stays within this range, alarm is inactive for the sensor.
- **Hysteresis** – sets the hysteresis to prevent repeated alarms when the reading fluctuates near a Safe Range threshold. For more details, see *Sensor hysteresis*.
- **Alarm Alert** – list of alarm settings for each sensor (alarm is triggered by reading out of the safe range).
- Line background color:
 - **White / no color** = input is not in alarm.
 - **Red** = input is in alarm.
 - **Yellow** = alarm is disabled for this input but the value is out of the safe range.

Digital Inputs (DI)

This section displays current states of dry contact inputs, including alarm states and settings. Active alarm is indicated by a red background of the corresponding line.

- **Name** – textual name of the input, assigned by user at the **Inputs** tab.
- **ID** – unique input ID number, as marked on the unit.
- **Current Value**
 - **0 (Off)** – open contact.
 - **1 (On)** – closed contact.
- **Alarm Alert** – list of alarm settings for each input (triggered by values out of safe range).
- **Counter** – Poseidon2 inputs feature pulse counters; this can be used for example to read energy consumption from meters with a pulse output (SO). Counters are incremented whenever the input is closed. The pulse must be longer than 20ms to be registered.
- Line background color:
 - **Default color** = input is not in alarm.
 - **Red** = input is in alarm.

Digital Outputs

Displays current output states, including their modes.

- **Name** – textual name of the output, assigned by user at the **Outputs** tab.
- **ID** – unique output ID number, as marked on the unit.
- **Current Value**
 - **0 (Off)** – output is idle (open, COM + NO connected).
 - **1 (On)** – output is active (closed, COM + NC connected).
- **Mode** – output mode, configured at the **Outputs** tab.

Other information

- **MIB** – links to the SNMP definition file (right-click the link and select “Save Target as...” to save the file to disk).
- **OID** (SNMP Object Identifier) – provides a list of the most frequent SNMP OIDs (right-click the link and select “Save Target as...” to save the file to disk).
- **XSD** – links to the XML definition file for the values.xml file (right-click the link and select “Save Target as...” to save the file to disk).

- **Terminal Config (TCP Setup)** – link containing the IP address and the port to open a terminal session for TCP Setup.
- **Text and link “For more information try www.HW-group.com”** – customizable link to the supplier or service provider. The text can be changed in **TCP Setup**, see the detailed description of *TCP Setup*.

Note: The design of the main page can be only customized after consulting the manufacturer, under our “Customization” program. For more information, contact your distributor.

General Setup

Network settings of the device: Network parameters, trusted IP address range, temperature units, output states, etc.

Poseidon2 4002 GENERAL SETUP

Device

Name	Value
Device Name:	Poseidon2 4002

Network Settings

Name	Value
IP Address:	192.168.100.63
Submask:	255.255.255.0
Gateway:	192.168.100.1
Primary DNS:	192.168.100.237
Secondary DNS:	192.168.100.250
HTTP Port:	80 0=dis, def 80
HTTPS Port:	443 0=dis, def 443
TCP Telnet Setup:	99 0=dis, def 99
Modbus TCP Port:	502 0=dis, def 502
DHCP Client:	<input checked="" type="checkbox"/>

IPV6

Name	Value
Enable IPv6:	<input type="checkbox"/>
Autoconfig IP parameters:	
Link Local Address:	
IP Address / Prefix length:	
Gateway:	
Primary DNS:	
Secondary DNS:	

Other settings and information

Name	Value
Display temperature in:	Celsius [°C]
System temperature in:	Celsius [°C]
Syslog IP Address:	0.0.0.0
HW Security Protection:	Disabled

For more information try <http://www.hw-group.com/>

Device name

Name assigned to this particular device. This name is shown in all overviews along with the IP address (**HWg Config**); it is also used as the sysname variable in SNMP.

Network Settings

This block configures the main network parameters for Ethernet communication:

- **IP address** – IP address of the unit. After a change, the device needs to be restarted.
- **Submask** – local network mask. After a change, the device needs to be restarted.
- **Gateway** – default gateway. After a change, the device needs to be restarted.
- **Primary DNS/Secondary DNS** – primary and secondary DNS server settings. Gateway needs to be set correctly for correct operation. A DNS server is necessary for converting domain names to IP addresses. Without a correctly configured DNS server, the following functions will not work:
 - Time sync (SNTP), used in e-mails and SNMP traps to timestamp events.
 - E-mailing (SMTP).
 - Logging of values with timestamps.
- **HTTP port** – port for communication using the HTTP protocol. Default is 80.
- **HTTPS port** – port for communication using the HTTPS protocol. Default is 443.
- **TCP Telnet Setup** – port for the terminal telnet setup mode. Default is 99.
- **Modbus TCP Port** – port for communication using the Modbus/TCP protocol. Default is 502.
- **DHCP Client** – activates automatic network configuration using a DHCP server. Enabled by default.

IPV6

This block groups options for operation in networks that support IPv6.

- **Enable IPV6** – enables IPv6 support.
- **Autoconfig IP parameters** – enables automatic network configuration using SLAAC.
- **Link Local Address** – link address of the device; only visible from the local network.
- **IP Address / Prefix length** – global (public) IP address and network prefix. Consists of the link address and the network prefix.
- **Gateway** – default gateway. After a change, the device needs to be restarted.
- **Primary DNS/Secondary DNS** – primary and secondary DNS server settings. Gateway needs to be set correctly for correct operation.

Other Settings and Information

- **Display Temperature In** – specifies the temperature measurement unit (C – Celsius / centigrade, F – Fahrenheit, K – Kelvin). The setting only applies to the WWW interface. All other interfaces and protocols use °C, unless specified otherwise in the interface description.
- **System temperature in** – specifies the temperature measurement unit for communication protocols and logs. Available options are degrees Celsius (default due to backward compatibility) or “by Display temp”, which uses the unit selected in the “Display temperature in” field.
- **Syslog IP Address** – IP address of the SYSLOG server for log messages.
- **HW Security Protection** – mechanical jumper can prevent any changes in the device configuration.
 - **Outputs:** Values of outputs can be changed.
 - **Configuration:** No changes to the device settings are permitted.

The protection status is displayed in the bottom left-hand corner. When the HW Protection is active, any configuration changes, including changes of the output states, are ignored. This mode is useful when connecting the Poseidon2 to a publicly accessible network.

Note: Any changes must be confirmed by clicking the *Apply Changes* button. A successful change is indicated by an animation in the status bar next to the *Apply Changes* button.

Counters

Resets the counter states at all device inputs – see *Inputs*. Resetting the device also resets the counters.

Security

Security

Security settings. Restrictions in individual modes are shown in the following table. The rows indicate the method of accessing the device over IP, the columns specify the restrictions resulting from the respective security settings.

	No restrictions (default)	HW protection DIP = On	User Password			IP Access filter		SNMP Communities	
			Read only	Read + Outputs	Read & Write	HTTP	SNMP	Comun1	Comun2
Web index (General)	✓	✓	✓	✓	✓	filtered	✗	✗	✗
Other pages	R/W	R	R	R/W**	R/W	filtered	✗	✗	✗
Values.xml	R	R	R	R	R	filtered	✗	✗	✗
Setup.xml	R/W	R	R	R/W**	R/W	filtered	✗	✗	✗
SNMP get (next)	R	R	✗	✗	✗	✗	filtered	R*	R*
SNMP set	W	✗	✗	✗	✗	✗	filtered	[R*/]W*	[R*/]W*
Modbus/TCP	R/W	R	✗	✗	✗	✗	✗	✗	✗
TCP setup	✓	✗	✗	✗	✓	✗	✗	✗	✗
HWg Config	R/W	R	✗	✗	✗	✗	✗	✗	✗
FW update	✓	✗	✗	✗	✓	filtered	✗	✗	✗
M2M outputs	R/W	R/W	R	R/W	R/W	✗	✗	✗	✗

* R and/or W must be enabled on the **SNMP Setup** tab by checking appropriate boxes.

** Only outputs can be changed, nothing else. Even the output mode cannot be changed.

Note: The "No restrictions" column reflects the default configuration (also shown in the screenshots). That is, HW protection DIP=Off, no password set, IP Access filter set to 0.0.0.0/0.0.0.0.



- General
- General setup
- Security**
- SNMP
- Email
- GSM
- Log & Time
- Portal
- MQTT
- Sensors
- Inputs
- Outputs
- Virtual Outputs
- System

Version: 3.3.3

Apply Changes

SECURITY

Poseidon2 4002

IP Access Filter

IP Address Value	IP Mask Range	HTTP	SNMP
0.0.0.0	0.0.0.0	<input type="checkbox"/>	<input type="checkbox"/>
0.0.0.0	0.0.0.0	<input type="checkbox"/>	<input type="checkbox"/>
0.0.0.0	0.0.0.0	<input type="checkbox"/>	<input type="checkbox"/>
0.0.0.0	0.0.0.0	<input type="checkbox"/>	<input type="checkbox"/>
0.0.0.0	0.0.0.0	<input type="checkbox"/>	<input type="checkbox"/>

User Passwords

User Name	Password
Read Only: <input type="text"/>	<input type="text"/>
Read Only + Outputs: <input type="text"/>	<input type="text"/>
Read and Write: <input type="text"/>	<input type="text"/>

HTTPS Server Certificate files

Name	Value
Type: SSLCertificateFile Description: Public key certificate file, ext. *.crt Filename: *.crt Import file: Vybrat soubor Soubor nevybrán <input type="button" value="Upload"/> Edit File: <input type="button" value="Delete File"/>	
Type: SSLCertificateKeyFile Description: Secret key file, ext. *.key Filename: *.key Import file: Vybrat soubor Soubor nevybrán <input type="button" value="Upload"/> Edit File: <input type="button" value="Delete File"/>	
Type: SSLCACertificateFile Description: CA certificate file, ext. *.pem Filename: *.pem Import file: Vybrat soubor Soubor nevybrán <input type="button" value="Upload"/> Edit File: <input type="button" value="Delete File"/>	

Generate a private SSL key and selfsigned certificate for closed networks or testing purposes. The generated certificate is selfsigned and will be displayed as untrusted. Please add the certificate to the list of exceptions or use a certificate signed by a trusted certification authority. Please note that the generated data will replace the SSLCertificateFile and the SSLCertificateKeyFile. Generating the key can take up to 10minutes. Do not restart the device and do not search for sensors. Otherwise the key generation will be interrupted.

For more information try <http://www.hvr-group.com/>

IP Access Filter

Allows defining a range of trusted IP addresses that are allowed to access the Poseidon2 over HTTP and SNMP. The IP range is configured separately for each protocol.

To set up the filter, specify the base IP address and the mask that define the trusted range according to the formula below (AND is bitwise multiplication). Access is granted if the condition is true.

$$(IP \text{ trying to access AND Mask Value}) = IP \text{ Address Value}$$

IP Filter settings		Access granted to from .. to	Note
IP Address Value	Mask Value		
192.168.1.2	192.168.1.2	192.168.1.2	Only one IP allowed
192.168.1.87	192.168.1.87	192.168.1.87	Only one IP allowed
192.168.1.0	192.168.1.224	192.168.1.0..192.168.1.31	32 allowed addresses
192.168.1.0	192.168.1.0	192.168.1.0..192.168.1.255	All 192.168.1.x addresses (256) allowed
192.168.0.2	192.168.254.255	192.168.0.2 and 192.168.1.2	Only 1 address but on two networks
192.168.0.0	192.168.252.240	192.168.0.0..192.168.0.15 192.168.1.0..192.168.1.15 192.168.2.0..192.168.2.15 192.168.3.0..192.168.3.15	4× 16 addresses allowed

User Passwords

Three separate user accounts (username and password) can be set up for SNMP and HTTP access.

- Account types:
 - **Read Only** – can only read values and configuration settings.
 - **Read Only + Outputs** – can read values and set outputs, cannot change configuration settings (not even input names).
 - **Read & Write** – can perform any changes.
- The “Read Only” account has only read access to values, cannot perform any configuration changes. The “Read&Write” account can change configuration settings.
- After setting up a username and a password, you will be asked to log in every time you try to open the Web interface.
- Passwords also apply to access to /values.xml and /setup.xml – see the table.

In case of “Read Only” user for HTTP access, you will no longer be able to change configuration settings in the web interface.

What to do if you forget your password

- Restore the factory-default configuration of the device by one of the following methods:
 - Use the **HWg Config** utility (on a PC in the same LAN).
Right-click the line corresponding to the device and select “**Load to defaults**” from the pop-up menu.
 - Use the **DIP Load default** function.
Toggle DIP1 several times during the first 5 seconds after powering up the device.

HTTPS Server Certificate files

Used to manage certificates needed for the HTTPS server. Allows you to upload or delete a public key, a private key, or a certificate of the certificate authority (CA) that has issued the public key certificate.

Generate the SSL key and certificate

Generate a private SSL key and self-signed certificate for closed networks or testing purposes. The generated certificate is self-signed and will be displayed as untrusted. Please add the certificate to the list of exceptions or use a certificate signed by a trusted certification authority. Please note that the generated data will replace the SSLCertificateFile and the SSLCertificateKeyFile. Generating the key can take up to 10 minutes. Do not restart the device and do not search for sensors. Otherwise the key generation will be interrupted.

SNMP

The SNMP tab allows to configure the settings for communication with Poseidon2 using the SNMP protocol. The page content is slightly different for SNMPv1 and SNMPv3. See the next sections for details.

SNMPv1

General SNMP Settings

- **SNMP port** – communication port to use for the SNMP protocol **[161]**.
- **SNMP Port Listener** – port for receiving SNMP traps from Poseidon2 and Damocles2 devices in Box2Box communication mode **[162]**.
- **SNMP Version** – configures SNMP protocol version **[1]**.

SNMP Access

Defines names and access rights for user groups that can work with the Poseidon2 unit.

- **Community** – textual name of the authorized group (by default **Public** and **Private**).
 - **Read** – the community is authorized to read variables over SNMP.
 - **Write** – the community is authorized to write values to variables over SNMP.

SNMP Trap Destination

Destinations for sending SNMP Traps.

- **Community** – textual name of the group for the SNMP trap being sent.
- **IP address** – destination address where the SNMP traps are sent.
- **Port** – destination port where the SNMP traps are sent.

SNMP Communities

- **Community** – textual name of the security group.

MIB II System Group

User-defined data in the standard SNMP header.

- **SysContact** – contact information of the system administrator, e.g. an e-mail address.
- **SysName** – same as the device name.
- **SysLocation** – location of the unit, e.g. "IT room, floor 2".

Note: Any changes must be confirmed by clicking the **Apply Changes** button. A successful change is indicated by an animation in the status bar next to the **Apply Changes** button.

SNMPv3

The screenshot shows the web interface for the Poseidon2 4002 device, specifically the SNMP configuration page. The interface is divided into several sections:

- General SNMP Settings:** Includes fields for SNMP Port (161), SNMP Port Listener (162), and SNMP Version (3).
- SNMP Access:** A table with columns for User name, Read, and Write. It shows 'Public' and 'Private' users with their respective permissions.
- SNMP Trap Destinations:** A table with columns for Destination (A-E), User name, IP Address, and Port. Destination A is configured with 'Public' user, IP 192.168.1.39, and port 162. Destinations B-E are disabled.
- SNMP Users:** A table with columns for User name, Auth. Type, Auth. Password, Privacy Type, and Privacy Password. It shows 'Public' and 'Private' users with their authentication and privacy settings.
- MIB II System Group:** Fields for SysContact (support@HWgroup.cz), SysName (Poseidon2.4002), and SysLocation.

At the bottom of the page, there is a status bar with the text "Version: 3.3.3" and an "Apply Changes" button.

General SNMP Settings

- **SNMP port** – communication port to use for the SNMP protocol **[161]**.
- **SNMP Port Listener** – port for receiving SNMP traps from Poseidon2 and Damocles2 devices in Box2Box communication mode **[162]**.
- **SNMP Version** – configures SNMP protocol version **[3]**.

SNMP Access

Defines names and access rights for user groups that can work with the Poseidon2 unit.

- **User name** – textual name of the authorized group (by default **Public** and **Private**).
 - **Read** – the community is authorized to read variables over SNMP.
 - **Write** – the community is authorized to write values to variables over SNMP.

SNMP Trap Destination

Destinations for sending SNMP Traps.

- **User name** – textual name of the group for the SNMP trap being sent.
- **IP address** – destination address where the SNMP traps are sent.
- **Port** – destination port where the SNMP traps are sent.

SNMP Users

User names and passwords for SNMPv3 communication.

- **User name** – user name.
- **Auth. Type** – cipher type for user authentication. Available options are MD5 and SHA.
- **Auth. Password** – password for user authentication.
- **Privacy Type** – cipher type for encrypting the communication. Available options are DES and AES.
- **Privacy Password** – password (key) for encrypting the communication.

MIB II System Group

User-defined data in the standard SNMP header.

- **SysContact** – contact information of the system administrator, e.g. an e-mail address.
- **SysName** – same as the device name.
- **SysLocation** – location of the unit, e.g. "IT room, floor 2".

Note: Any changes must be confirmed by clicking the **Apply Changes** button. A successful change is indicated by an animation in the status bar next to the **Apply Changes** button.



- General
- General setup
- Security
- SNMP
- Email**
- GSM
- Log & Time
- Portal
- MQTT
- Sensors
- Inputs
- Outputs
- Virtual Outputs
- System

Poseidon2 4002
EMAIL

Email Settings

Name	Value	
SMTP Server:	<input type="text" value="some smtp.server"/>	[IP Address or DNS Name]
SMTP port:	<input type="text" value="25"/>	
Email Sender Address:	<input type="text" value="user@domain.com"/>	
Authentication:	<input type="checkbox"/>	
Secure TLS mode:	<input type="checkbox"/>	
Name/Password:	<input type="text" value="User login name"/>	<input type="text"/>
Email Subject Text:	<input type="text" value="Subject_0"/>	

Email Destinations

Name	Value
Alarm Email Recipient:	<input type="text" value="To0@domain.com"/>
Alarm Email Copy:	<input type="text" value="To1@domain.com"/>
Alarm Email Copy:	<input type="text" value="To2@domain.com"/>
Alarm Email Copy:	<input type="text" value="To3@domain.com"/>
Alarm Email Copy:	<input type="text" value="To4@domain.com"/>
Periodic Log Recipient:	<input type="text" value="To5@domain.com"/>

Test Email

Name	Value
State:	<input type="text"/>

Periodic Status Settings

Name	Value	
Periodical Status:	<input type="checkbox"/>	Period: <input type="text" value="60"/> [minutes]
Alarm reminder:	<input type="checkbox"/>	Period: <input type="text" value="5"/> [minutes]

For more information try <http://www.hw-group.com/>

- **SMTP Server** – host name or IP address of the SMTP server.
- **SMTP Port** – port for communication with the SMTP server (**25** by default).
- **Email Sender Address** – e-mail address that will be shown in the "From" field.
- **Authentication** – enables username/password authentication if the SMTP server requires it.
- **Secure TLS mode** – activates SSL/TLS authentication (e.g. for gmail).
- **Name** – username for authentication with the SMTP server.
- **Password** – password for authentication with the SMTP server.
- **Email Subject Text** – subject of the e-mails sent, followed by the default e-mail text (see e-mail format).
- **Alarm Email Recipient** – e-mail address of the main recipient (To).
- **Alarm Email Copy** – e-mail address of the carbon-copy recipient (Cc).
- **Periodic Log Recipient** – e-mail address of the recipient for periodically e-mailed logs.
- **Send Test Email** button – sends a test e-mail.

Periodic Status Settings

- **Periodical Status** – when enabled, sends an e-mail with device status at the specified intervals. For example every 24 hours (1440 minutes).
- **Alarm reminder** – when active, sends periodic reminders that the device is in the Alarm state. For example every 15 minutes.

To send e-mail, check:

<ol style="list-style-type: none"> 1. Correct Gateway IP address 2. DNS server in the network settings 3. SMTP server and port 	<ol style="list-style-type: none"> 4. Authentication enabled, correct username and password 5. Spam filter for your mailbox is disabled
--	---

Tip: It is not always necessary to configure a **SMTP Server** in order to send e-mails. Poseidon2 can work as SMTP server itself and deliver the e-mails directly to the user's mailbox. However, always test this mode in your particular environment – the e-mails sent in this mode are often blocked by various spam filters due to missing reverse MX records. Poseidon2 can only send e-mails, it cannot receive them.

Received e-mail example

This e-mail is sent upon every alarm activation and deactivation.

DATE	TIME	Device_NAME	Device_IP
10.10.2005	15:04:27	Server_room1	192.168.1.20

Email initiated:	48245	T-Room	Alarm ACTIVATED
------------------	-------	--------	-----------------

ID	SENSOR_Name	VALUE	UNIT	Safe_RANGE	ALARM
----	-------------	-------	------	------------	-------

ALARM state:

48245	T-Room	25.30	°C	-45.0 .. 22.0	Enabled
1	C-water	OFF			if OFF

Sensors list:

48245	T-Room	25.30	°C	-45.0 .. 22.0	Enabled
1559	H-Room	53.00	%RH	30.0 .. 80.0	Enabled
48	T-Srv01	-27.30	°C	-49.0 .. -25.1	Disabled
257	ABCDEFGHJKLMNO	-109.30	°C	-150.0 .. -105.0	Enabled
1	C-water	OFF			if OFF
2	C-AirFl	OFF			if ON
3	C-Door1	OFF			Disabled

Server_room1:	http://192.168.1.20	00:0A:59:00:00:00
---------------	---------------------	-------------------

Tip: For detailed description of the e-mail format, see the "Using Poseidon2 units in your programs".

Sending a test e-mail

Multiple systems need to be configured correctly in order to send e-mails from the device successfully. Therefore, it is advisable to double-check the following parameters:

- **Gateway** in the network settings.
- **DNS server** in the network settings.
- **SMTP server** and port.
- **Authentication** enabled, correct **username** and **password**.
- **Spam filter** for your mailbox is disabled.

GSM

Poseidon2 4002 GSM

Serial Port Settings

Name	Value
Port Function:	Disabled

Remote SMS gateway

Name	Value
Enable:	<input checked="" type="checkbox"/>
IP Address or DNS Name:	bigboss.hwgroup.cz
Link/Path:	service.xml
Port:	8085
Username:	hwgroup
Password:	****

GSM SMS Interface

Name	Value
GSM Function:	Remote
SMS + Ring When Alarm:	<input checked="" type="checkbox"/>

GSM SMS Recipients

Name	Value	Test
Alarm SMS Recipient 1:	777232759	<input type="button" value="Send Test SMS"/>
Alarm SMS Recipient 2:		<input type="button" value="Ringout Test"/>
Alarm SMS Recipient 3:		
Alarm SMS Recipient 4:		
Alarm SMS Recipient 5:		

For more information try <http://www.hw-group.com/>

Serial Port Settings

Port Function – sets the serial port function (only for models with a serial port and the netGSM server side feature). 2 options are available:

- **Disabled** – serial port is off. Only if no modem is connected and the device works as the client side.
- **GSM modem** (Poseidon2 4002 only) – a GSM modem is connected, and Poseidon2 also acts as a netGSM server.

Remote SMS gateway

Configures the IP address, HTTP port and path to the service for sending SMS requests. **For Poseidon2, the path is always service.xml.**

GSM SMS interface

Configures the parameters for sending text messages.

Serial Port Settings

Name	Value
Port Function:	GSM Modem

GSM SMS Interface

Name	Value
GSM Function:	Local
SMS + Ring When Alarm:	<input checked="" type="checkbox"/>
RS-232 GSM Module:	Not enabled
SMS Center Number:	

- **GSM Function** – selects whether SMS are sent through a local modem (only available if the serial port is in GSM Modem mode).
- **SMS+Ring when Alarm** – enables sending a SMS and then dialing the number.
- **RS-232 GSM module** – indicates if the GSM modem is ready.
 - **Not Enabled** – inactive. Shown after changing RS-232 port configuration but before saving it.
 - **Not Found** – Poseidon2 is configured for a locally-connected GSM modem but the modem was not found.
 - **Waiting for modem** – looking for the modem.
 - **Initializing** – the modem is being initialized.
 - **Ready** – the modem is ready.
- **SMS center Number** (only for Poseidon2 4002 with a RS-232 modem connected) – provider's SMS center number, as read from the SIM card. If the number has not been read, it is not possible to send SMS.

GSM SMS recipients

Configures the numbers of SMS recipients, regardless of the mode of operation (local/remote modem).

- **Send Test SMS** – sends a test SMS to all configured numbers.
- **RingOut Test** – dials all configured numbers.

Example of a received SMS:

- Device name: **Poseid11**
- Sensors in Alarm:
 - Rack11 = 48.5°C, threshold is 40°C
 - T-Room = 48.3°C, threshold is 35°C
 - H-Room = 10% RH, threshold is 45% RH

Poseidon2 ALARM: Rack11(48,5), T-Room(48,3), H-Room(10)

Tip: For detailed description of the SMS format, see the "Using Poseidon2 units in your programs".

Note: Any changes must be confirmed by clicking the Apply Changes button. A successful change is indicated by an animation in the status bar next to the Apply Changes button.

Log & Time

This tab lets you configure the date, time, and logging options (if supported by the particular Poseidon2 model).

Poseidon2 4002 LOG AND TIME

Date and Time

Name	Value	Description
Current Date:	04.10.2017	[dd.mm.yyyy]
Current Time:	14:28:39	[24 hour format]

Time Synchronization

Name	Value	Description
SNTP Server:	time.nist.gov	[IP Address or DNS Name]
Time zone:	+1hour 0 min	
Interval:	10 hour	
Daylight saving time:	Central European	

Sync period: 1h/10h/24h
last Sun March 2:00 - last Sun October 3:00

Device Logger Settings

Name	Value	Description
Log period:	300 [s]	
Logfile capacity:	114days, 22hours and 22minutes	
Report Log Period:	1 [h]	
Erase log after e-mail:	<input checked="" type="checkbox"/>	

Open log File Clear log File

Version: 3.3.3

Apply Changes

For more information try <http://www.hw-group.com/>

Date and Time

Current date and time settings.

- **Current Date** – date in the [dd.mm.yyyy] format, for example: **04.10.2017**.
- **Current Time** – current time in the 24-hour [hh:mm:ss] format, for example: **14:28:39**. The time increases automatically while the browser window is open.

Time Synchronization

SNTP server settings for time synchronization. If the time is not set (the date 1. 1. 1970 is displayed), the device attempts to synchronize the time approximately once per hour until successful.

- **SNTP Server** – IP address or host name of the SNTP server to synchronize the time with. Preconfigured server is ntp1.sth.netnod.se.

Note: The clock does not run when Poseidon2 is powered off. The unit contains no battery. After a power failure, the time will be synchronized with the SNTP server.

Data Logger Settings

Configuration parameters for logging values to a circular buffer within the internal flash memory. When the buffer is full, the oldest values are overwritten with the newest ones. This function is supported only by certain Poseidon2 models.

- **Log Period** – period of logging into the logfile for all values.
- **Logfile capacity** – the capacity estimate is given in days, hours and minutes. Poseidon2 calculates the capacity based on the number of sensors detected.
Caution: When the circular buffer is full, the remaining capacity shown will be zero. Clear the buffer to find out the total capacity.
- **Report Log Period** – period for e-mailing the log.
- **Erase log after e-mail** – the log is cleared after it is e-mailed. This reduces attachment size and can speed up data transfer.
- **Open log File** – stores the current logfile to disk by invoking the external **/spilog.txt** file.
- **Clear log File** – clears all values from the logfile by calling the external **/spilog.del** file.

Note: Any changes must be confirmed by clicking the Apply Changes button. A successful change is indicated by an animation in the status bar next to the Apply Changes button.

Portal

Configures the communication with the portal using the HWg-Push protocol. Poseidon2 is the active side and establishes the connection periodically and/or whenever a change in a sensor value exceeds the configured AutoPush value.

Poseidon2 4002 PORTAL

Portal Message

Value
Portal disabled

Portal

Name	Value
Portal Enable:	<input type="checkbox"/>
Server Address:	www.sensdesk.com/portal.php
IP Port:	80 Default: 80
User Name:	
Password:	
Current Push Timer:	0
Current Log Timer:	0
Current Check Timer:	0
Cur. Autopush Block Timer:	0
Retransmit number:	0

Manual Push

Sensors autopush config

Name	ID	Current Value	Autopush
Sensor 240	61964	42.7 %RH	0.0
Sensor 241	55824	23.9 °C	0.0

Digital Inputs (DI) autopush config

Name	ID	Current Value	Autopush
Binary 1	1	0(Off)	<input type="checkbox"/>
Binary 2	2	0(Off)	<input type="checkbox"/>
Binary 3	3	0(Off)	<input type="checkbox"/>
Binary 4	4	0(Off)	<input type="checkbox"/>
Binary 5	5	0(Off)	<input type="checkbox"/>
Binary 6	6	0(Off)	<input type="checkbox"/>
Binary 7	7	0(Off)	<input type="checkbox"/>
Binary 8	8	0(Off)	<input type="checkbox"/>
Binary 9	9	0(Off)	<input type="checkbox"/>
Binary 10	10	0(Off)	<input type="checkbox"/>
Binary 11	11	0(Off)	<input type="checkbox"/>
Binary 12	12	0(Off)	<input type="checkbox"/>
Comm Monitor 1	123	0(Off)	<input type="checkbox"/>

Version: 3.3.3

Apply Changes

For more information try <http://www.hw-group.com/>

Connection parameters for the www.SensDesk.com portal are pre-filled.

Portal Message

Information from the portal, such as links to graphs. Depends on the portal type.

Portal

- **Portal enable** – turns this feature on or off.
- **Server Address** – complete URL of the remote server.
- **IP Port** – port where the portal listens.
- **User Name** – user name for assigning to a user. You will receive it from your portal administrator.
- **Password** – password for assigning to a user. You will receive it from your portal administrator.
- **Current Push Timer** – indicates the remaining time before the next periodic data upload.
- **Current Log Timer** – indicates the remaining time before the next caching of data.
- **Current Autopush Block Timer** – indicates the delay from one AutoPush upload to the next. The period is configured from the portal.
- **Retransmit number** – number of retransmissions if a Push fails.
- **Manual Push** – button for immediate manual upload of data to the portal.

AutoPush configuration

Poseidon2 connects to the portal immediately and notifies a value change whenever a change in the sensor reading exceeds the configured AutoPush value.

This configuration only applies to the communication between Poseidon2 and the online portal. Local alarm values are configured in the portal.

For portal connection, check:

1. Correct **Gateway IP** address
2. **DNS server** in the network settings
3. Correct **Server Address** of the portal

MQTT

Used to connect Poseidon2 to an IoT network using the MQTT protocol.

Poseidon2 4002 MQTT

MQTT Settings

Name	Value	Description
MQTT Enable:	<input type="checkbox"/>	Enable/Disable MQTT Client services.
Server:	iot.eclipse.org	[IP Address or DNS Name]
Port:	1883	Default 1883 or 8883 for SSL.
Username:		
Password:		
Secure SSL mode:	<input type="checkbox"/>	
Client ID:		
Publish Period:	60	
Topic Prefix Name:		

Sensors Topic

Name	ID	Publish	Topic Name = value
Sensor 240	61964	<input type="checkbox"/>	61964/Value = 42.0 %RH 61964/State = 0
Sensor 241	55824	<input type="checkbox"/>	55824/Value = 24.1 °C 55824/State = 0

Inputs Topic

Name	ID	Publish	Topic Name = value
Binary 1	1	<input type="checkbox"/>	1/Value = 0 1/State = 0
Binary 2	2	<input type="checkbox"/>	2/Value = 0 2/State = 0
Binary 3	3	<input type="checkbox"/>	3/Value = 0 3/State = 0
Binary 4	4	<input type="checkbox"/>	4/Value = 0 4/State = 0
Binary 5	5	<input type="checkbox"/>	5/Value = 0 5/State = 0
Binary 6	6	<input type="checkbox"/>	6/Value = 0 6/State = 0
Binary 7	7	<input type="checkbox"/>	7/Value = 0 7/State = 0
Binary 8	8	<input type="checkbox"/>	8/Value = 0 8/State = 0
Binary 9	9	<input type="checkbox"/>	9/Value = 0 9/State = 0
Binary 10	10	<input type="checkbox"/>	10/Value = 0 10/State = 0
Binary 11	11	<input type="checkbox"/>	11/Value = 0 11/State = 0
Binary 12	12	<input type="checkbox"/>	12/Value = 0 12/State = 0
Comm Monitor 1	123	<input type="checkbox"/>	123/Value = 0 123/State = 0

Outputs Topic

Name	ID	Publish	Topic Name = value
BinOut 1	151	<input type="checkbox"/>	151/Value = 0
BinOut 2	152	<input type="checkbox"/>	152/Value = 0
BinOut 3	153	<input type="checkbox"/>	153/Value = 0
BinOut 4	154	<input type="checkbox"/>	154/Value = 0

User Topic

Name	Value
User Topic Enable:	<input type="checkbox"/>
Topic Name:	
Topic Value:	
Topic Test:	

Test User Topic

For more information try <http://www.hw-group.com/>

MQTT Settings

- **MQTT Enable** – enables or disables data transfer using the MQTT protocol.
- **Server** – IP address or domain name of the MQTT broker server.
- **Port** – TCP port where the MQTT broker listens (default is 1883, or 8883 for SSL).
- **Username** – user name for logging in to the MQTT broker.
- **Password** – password for logging in to the MQTT broker.
- **Secure SSL mode** – enables or disables SSL support when communicating with the MQTT broker.
- **Client ID** – device ID in the MQTT network.
- **Publish Period** – frequency of sending data to the MQTT broker.
- **Topic Prefix Name** – MQTT Topic (address) prefix.

Sensors Topic

- **Name** – corresponds to the **Name** at the **Sensors** tab.
- **ID** – corresponds to the **ID** at the **Sensors** tab.
- **Publish** – enables or disables the sending of information about a particular sensor.
- **Topic Name = value** – complete Topic after the prefix:
 - **x/Value** – current sensor value.
 - **x/State** – current sensor state.

Inputs Topic

- **Name** – corresponds to the **Name** at the **Inputs** tab.
- **ID** – corresponds to the **ID** at the **Inputs** tab.
- **Publish** – enables or disables the sending of information about a particular input.
- **Topic Name = value** – complete Topic after the prefix:
 - **x/Value** – current input value.
 - **x/State** – current input status.
 - **x/Counter** – current counter status.

Outputs Topic

- **Name** – corresponds to the **Name** at the **Outputs** tab.
- **ID** – corresponds to the **ID** at the **Outputs** tab.
- **Publish** – enables or disables the sending of information about a particular output.
- **Topic Name = value** – complete Topic after the prefix:
 - **x/Value** – current output value.

User Topic

User Topic can be used to create a user topic (message) with data needed by a custom application. To do that, the macro commands described below are available.

- **User Topic Enable** – enables the user topic (message).
- **Topic Name** – message name.
- **Topic Value** – user message template.
- **Topic Test** – preview of the resulting messages after the macros are processed.

For more information about MQTT and its use, see AN51 at the [HW-group.com](http://www.hw-group.com) website.

Macros:

- %ID_IN_*
 - %ID_IN_END%
 - %LOOP_IN%
 - %LOOP_IN_END%
 - %ID_OUT_*
 - %ID_OUT_END%
 - %LOOP_OUT%
 - %LOOP_OUT_END%
 - %ID_SENSOR_*
 - %ID_SENSOR_END%
 - %LOOP_SENSOR%
 - %LOOP_SENSOR_END%
 - %VAL_ID%
 - %VAL_VALUE%
 - %VAL_STATE%
- Start of sequence of the inputs with firmly defined ID's
 - End of the fixed sequence of the inputs
 - Beginning of the sequence of the inputs that passes all ID's
 - End of the complete sequence of the inputs
 - Start sequence of the outputs with firmly defined ID's
 - End of fixed sequence of the outputs
 - Start sequence outputs that passes all ID's
 - End of the complete sequence of the outputs
 - Start sequence with sensors firmly defined ID's
 - End of fixed sequence sensors
 - Start sequence of sensors that passes all ID's
 - End of the complete sequence of sensors
 - Variable ID item %VAL_NAME% variable name item
 - Variable values of the item
 - State variables of the item

Sensors

This tab configures the parameters for all sensors on both buses.

Find 1Wire + RS485 sensors and Find 1Wire sensors

Buttons to start the automatic detection of connected sensors. When the button is clicked, all other activity stops and the autodetection starts. The process can take a long time, even 2 minutes. When the detection completes, a dialog informs about the results. After a successful autodetection, all sensors are ready to measure.

Note: For a faster autodetection with a more detailed output, see the TCP Setup section.

The sensors must be with auto-detected after every change.

- **Name** – name of the input, up to 12 chars (e.g. “above door”, “area1 humid”).
- **ID** – unique sensor identifier, specifies its address on the bus. The range for sensors is **[65..150]** and **[256..65535]**.
- **Code** – full ID of the 1-Wire sensor.
- **Port** – number of the 1-Wire port (connector) at the device where the sensor is connected.
- **Value** – current sensor reading. Sensors that are not found or not working read as **-999.99**.
- **Safe Range** – range of values which are considered OK. When exceeded, alarm is raised. When configured to **15.0..35.0**, an e-mail is sent for values below **14.9** and above **35.1**.
- **Hysteresis** – defines a **tolerance band** when exceeding a threshold in order to avoid raising multiple alarms when the reading fluctuates near the threshold.

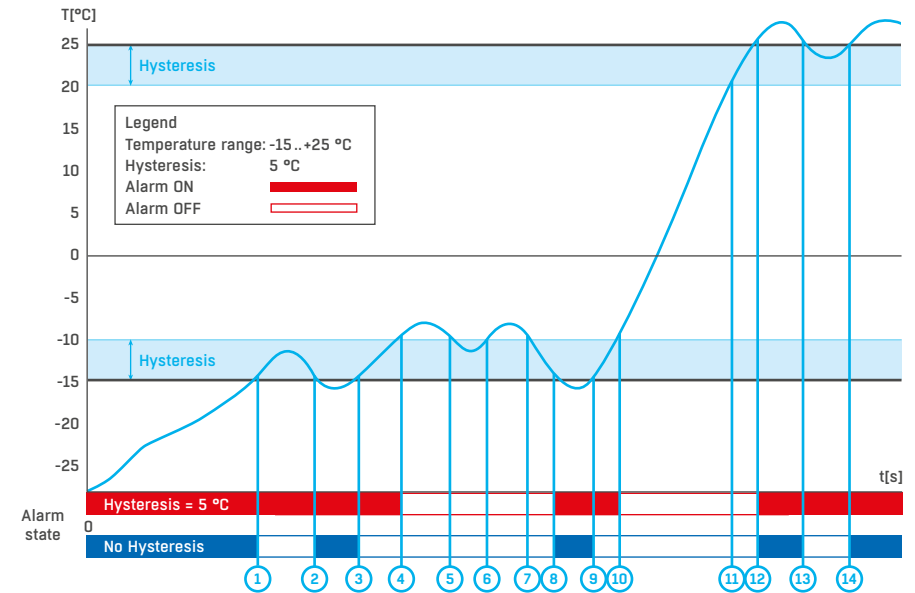

- **Delay [s]** – delays the sending of information about the beginning of the alarm.

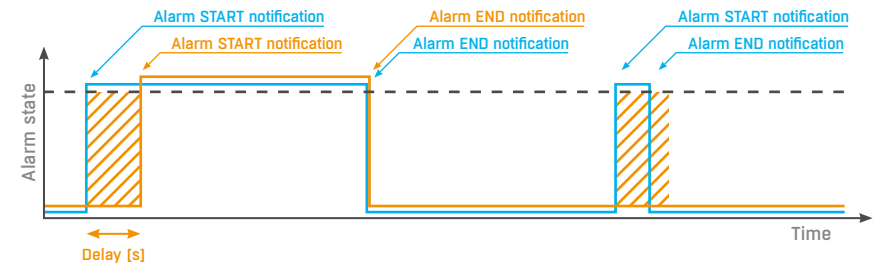

Alarm status notification based on a Delay value:

- **Blue:** Delay = 0
- **Yellow:** Delay is non-zero

- **SNMP Trap** – enables the sending of a SNMP trap upon alarm activation/deactivation.
- **Email** – enables the sending of an e-mail upon alarm activation/deactivation.
- **SMS** – enables the sending of a SMS upon alarm activation/deactivation.
- **Syslog** – enables the sending of SYSLOG messages.

Note: SMS (text messages) are sent through a GSM modem connected directly to the Poseidon2 unit via RS-232.

Inputs

Parameters for DI (Dry Contact Inputs).

Name	ID	Current Value	Alarm State	Delay[s]	SNMP Trap	Email	SMS	Syslog
Binary 1	1	1(On)	Active if on	0	<input type="checkbox"/>	<input type="checkbox"/>	<input type="checkbox"/>	<input type="checkbox"/>
Binary 2	2	0(Off)	Disabled	0	<input type="checkbox"/>	<input type="checkbox"/>	<input type="checkbox"/>	<input type="checkbox"/>
Binary 3	3	0(Off)	Disabled	0	<input type="checkbox"/>	<input type="checkbox"/>	<input type="checkbox"/>	<input type="checkbox"/>
Binary 4	4	0(Off)	Disabled	0	<input type="checkbox"/>	<input type="checkbox"/>	<input type="checkbox"/>	<input type="checkbox"/>
Binary 5	5	1(On)	Active if on	0	<input checked="" type="checkbox"/>	<input type="checkbox"/>	<input type="checkbox"/>	<input type="checkbox"/>
Binary 6	6	0(Off)	Disabled	0	<input type="checkbox"/>	<input type="checkbox"/>	<input type="checkbox"/>	<input type="checkbox"/>
Binary 7	7	0(Off)	Disabled	0	<input type="checkbox"/>	<input type="checkbox"/>	<input type="checkbox"/>	<input type="checkbox"/>
Binary 8	8	0(Off)	Disabled	0	<input type="checkbox"/>	<input type="checkbox"/>	<input type="checkbox"/>	<input type="checkbox"/>
Binary 9	9	0(Off)	Disabled	0	<input type="checkbox"/>	<input type="checkbox"/>	<input type="checkbox"/>	<input type="checkbox"/>
Binary 10	10	0(Off)	Disabled	0	<input type="checkbox"/>	<input type="checkbox"/>	<input type="checkbox"/>	<input type="checkbox"/>
Binary 11	11	0(Off)	Disabled	0	<input type="checkbox"/>	<input type="checkbox"/>	<input type="checkbox"/>	<input type="checkbox"/>
Binary 12	12	0(Off)	Disabled	0	<input type="checkbox"/>	<input type="checkbox"/>	<input type="checkbox"/>	<input type="checkbox"/>
Comm Monitor 1	123	0(Off)	Disabled	0	<input type="checkbox"/>	<input type="checkbox"/>	<input type="checkbox"/>	<input type="checkbox"/>

- **Name** – name of the input, up to 12 chars (e.g. “2f left door”, “smoke sect 1”).
- **ID** – unique ID of the input variable within the device [1 ..32].
- **Current Value** – current state of the input (“0 (Off)” / “1 (On)”).
- **Alarm State** – alarm state definition for each input.
 - **Active if On** – alarm is active whenever the input is in 1 (On).
 - **Active if Off** – alarm is active whenever the input is in 0 (Off).
 - **Disabled** – input has no alarm state defined.

- **Delay [s]** – delays the sending of information about the beginning of the alarm.

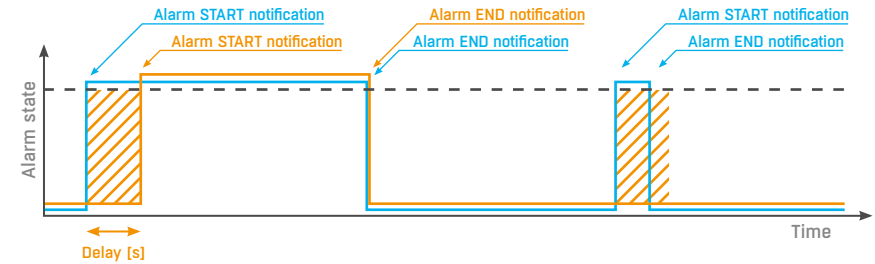

Alarm status notification based on a Delay value:

- **Blue:** Delay = 0
- **Yellow:** Delay is non-zero

- **SNMP Trap** – enables the sending of a SNMP trap upon alarm activation/deactivation.
- **Email** – enables the sending of an e-mail upon alarm activation/deactivation.
- **SMS** – enables the sending of a SMS upon alarm activation/deactivation.
- **Syslog** – enables the sending of SYSLOG messages.

Note: SMS (text messages) are sent through a GSM modem connected directly to the Poseidon2 unit via the RS-232 interface. See the list of Poseidon2 models for details.

Outputs

Controls the outputs and configures their modes.

ID	Current Value	Basic parameters	Output Control
151	0(Off)	Name: BinOut 1 ON (Closed) Name: On OFF (Open) Name: Off Pulse Timer: 0 Sec	Manual (selected) LocalCondition Change to On
152	0(Off)	Name: BinOut 2 ON (Closed) Name: On OFF (Open) Name: Off Pulse Timer: 0 Sec	Manual (selected) LocalCondition Change to On
153	0(Off)	Name: BinOut 3 ON (Closed) Name: On OFF (Open) Name: Off Pulse Timer: 0 Sec	Manual (selected) LocalCondition Change to On
154	0(Off)	Name: BinOut 4 ON (Closed) Name: On OFF (Open) Name: Off Pulse Timer: 0 Sec	Manual (selected) LocalCondition Change to On

Basic parameters

- **ID** – unique ID of the output within the device [151 ..215].
- **Current Value** – current state of the input (“0 (Off)” / “1 (On)”).
- **Name** – name of the output, up to 12 chars (e.g. “top fan”, “Door rack 4”).
- **ON (Closed) Name** – name of the “1 (On)” state – e.g. “closed”, “flooded”, “activated” etc.
- **OFF (Open) Name** – name of the “0 (Off)” state – e.g. “open”, “inactive” etc.
- **Pulse timer** – activates the input (switches to 1 (On) state) only for the defined period. To reverse the function, use the NO/NC relay output. When Pulse Timer = 0, the pulse function is disabled (default).

The pulse also applies to the local condition. The pulse width applies from the beginning of the local condition (safe value exceeded). There is only one pulse per satisfaction of the condition.

Output Control

- **Manual** – output controlled over the web or M2M protocols (XML, SNMP, ...).
 - **Change to On/Off** – change output state (after confirming with **Apply Changes**).
- **Local Condition** – output is controlled using a condition and a sensor. The output state is read-only for M2M protocols (**output cannot be controlled**). The control is linked to the Target Value, hysteresis is used (IDLE Range) as configured for the sensor.
 - **On if any alarm** – the output is closed if at least one of the inputs or sensors is in alarm.
 - Caution:** This condition also takes into account the DELAY and HYSTERESIS settings for individual active sensors and inputs.
 - **On if alarm on** – the output is closed whenever there is an Alarm at the selected sensor (input).
 - **On if value equal to Trigger** – the output is closed if the value matches the Target Value setting.
 - **On if value higher than Trigger** – the output is closed if the Current Value is greater than the Target Value setting.
 - **On if value lower than Trigger** – the output is closed if the Current Value is less than the Target Value setting.
- **Trigger Value** – trigger threshold for the condition (e.g. output is activated if the value is higher than the Trigger Value).
- **Dependent On** – selection of a sensor to which the condition applies.

Note: Output control conditions are not supported in Poseidon 2250. Local conditions are also called the **IP Thermostat mode**.

Virtual Outputs (VDO)

Virtual Outputs allow the use of outputs of other Poseidon2 or Damocles2 units (Box2Box). The communication uses the TCP protocol and updates take place every 60 seconds. For more information, see <http://hw-group.us/support/virtual-outputs-in-poseidon2-and-damocles2-units>.

ID	Virtual Type	Basic parameters
1151	Network Output	Name: VirtBinOut 1 Remote device address: 192.168.100.10 Port: 80 Remote port ID: 151 Username: Password:
1152	Network Output	Name: VirtBinOut 2 Remote device address: 192.168.200.5 Port: 80 Remote port ID: 153 Username: admin Password:
1153	Disabled	Name: VirtBinOut 3 Remote device address: Port: 80 Remote port ID: 0 Username: Password:
1154	Disabled	Name: VirtBinOut 4 Remote device address: Port: 80 Remote port ID: 0 Username: Password:
1155	Disabled	Name: VirtBinOut 5 Remote device address: Port: 80 Remote port ID: 0 Username: Password:
1156	Disabled	Name: VirtBinOut 6 Remote device address: Port: 80 Remote port ID: 0 Username: Password:
1157	Disabled	Name: VirtBinOut 7 Remote device address: Port: 80 Remote port ID: 0 Username: Password:

- **ID** – unique ID of the output within the device **[1151 ..1158]**.
- **Virtual Type** – enables the virtual output functions.
- **Name** – name of the output, up to 12 chars (e.g. “top fan”, “Door rack 4”).
- **Remote device address** – IP address of the remote side where the output is controlled.
- **Port** – TCP port where the remote side listens.
- **Remote port ID** – output ID at the remote side. Corresponds to the ID at the **Outputs** tab at the remote side.
- **Username/Password** – if the remote side uses SW protection against unauthorized use, enter the **Read & Write** or the **Read & Outputs** password.

System

Communication Monitor

Monitors whether communication with Poseidon2 over selected protocols takes place, and if it doesn't within the specified time, a virtual **Comm monitor** input is activated.

Configuration

- **Upload** – uploads a XML file with the configuration from your PC.
- **Download** – stores the setup.xml file with device configuration to your HDD.

System

- **Uptime** – time of uninterrupted device operation (since last restart).
- **Restart device** – restarts the device.
- **Set Default Config** – restore factory-default settings.
- **Update FW** – loads a .HWg firmware file from your PC to the device.

Update Firmware

Updating the firmware over the WEB

Upload the firmware **in a .hwg file** over http to <http://x.x.x.x/upload/>.

Connection problems etc. must be avoided during file transfer. If the update fails, use the RS-232 method described above.

Firmware in the .HWg format is available at the Poseidon2 website, or on the supplied CD.

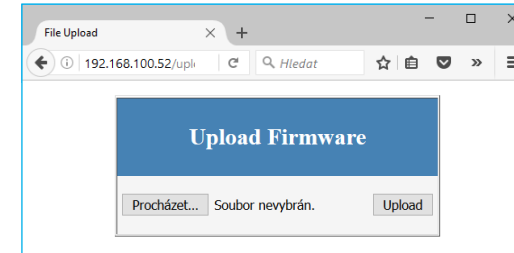

Firmware Update over RS-232

Poseidon2 4002 supports firmware updates over the RS-232 interface. The firmware consists of a single file with a .HWg extension that can be downloaded from our website.

Note: Please contact us in case of any problems with firmware upload.

Software applications

HWg-PDMS

Windows application that logs data from all HW group devices into its internal database. The application runs in the background (NT service). Data is retrieved from the devices over http or e-mail. Data can be exported over XML or automatically stored to MS Excel.



License:

- Free HWg-PDMS version for 3 sensors.
- Paid versions for 8/20/200/unlimited sensors (DI inputs).

HWg-Trigger

Windows application for detecting and reacting to events.

Detects, for instance, disconnected devices, failed sensors, values out of range, or incoming SNMP Trap alerts. Possible responses include sending an e-mail, activating a relay over the network, or sending a text message (SMS) using HWg-SMS-GW. Other responses include displaying a warning message in Windows, starting an application, or shutting down the computer.

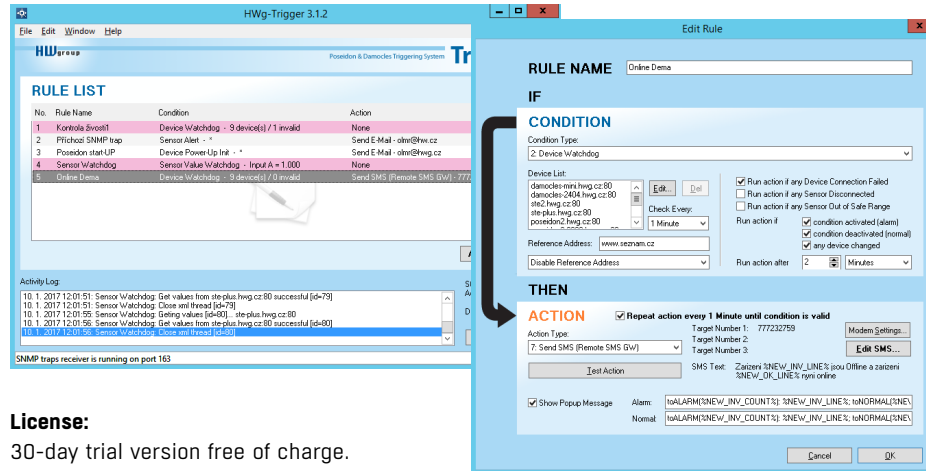

License:
30-day trial version free of charge.

PosDamIO

Poseidon Damocles I/O is a command-line utility for Windows and Linux that lets you control Poseidon2 and Damocles2 units over the XML interface. It can display the states of sensors, inputs and outputs, as well as set an output high or low.

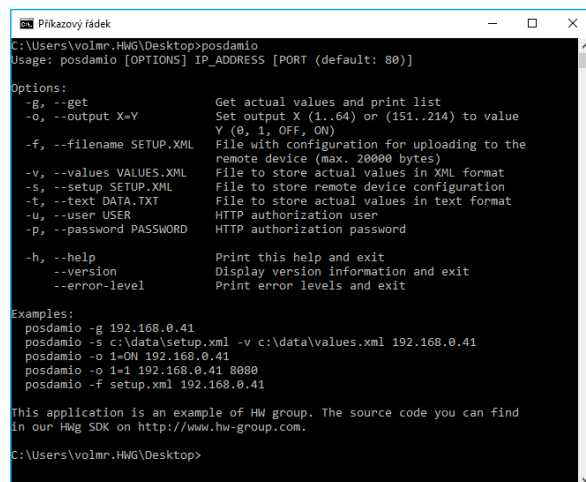

SensDesk.com

Online portal for collecting data from LAN and GSM sensors.

Poseidon2 can connect to the SensDesk internet service. All devices can be managed from a single WWW interface. Watch sensor states, display your devices in a map, compare trends in time and analyze alarm messages.

SensDesk is a way to implement fully functional monitoring of customer technology in a matter of minutes, with fixed costs of the system. There is no need to install complex systems or buy another customer-side server.

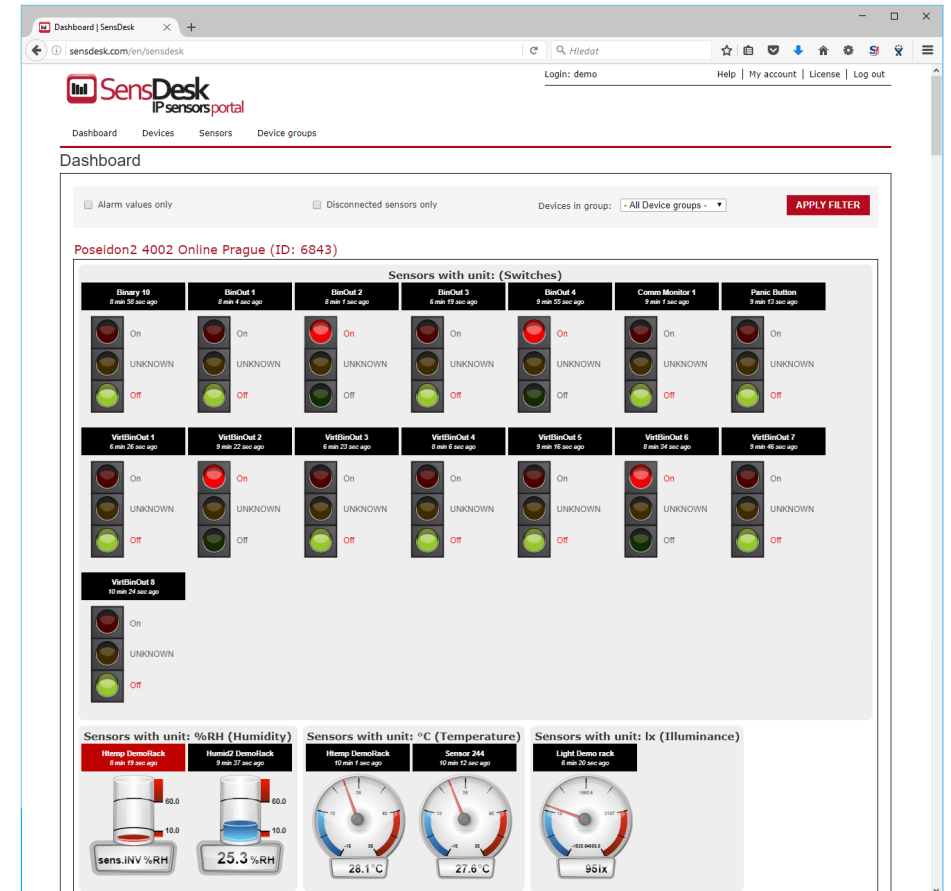

- Overview of all sensors at a single place.
- Centralized alarm configuration for individual sensors.
- Mobile app for monitoring.
- Remote configuration of GSM devices.

Connecting Poseidon2 to SensDesk

- 1 Connect the device to the network and configure the network parameters (see *First steps* in the user manual).

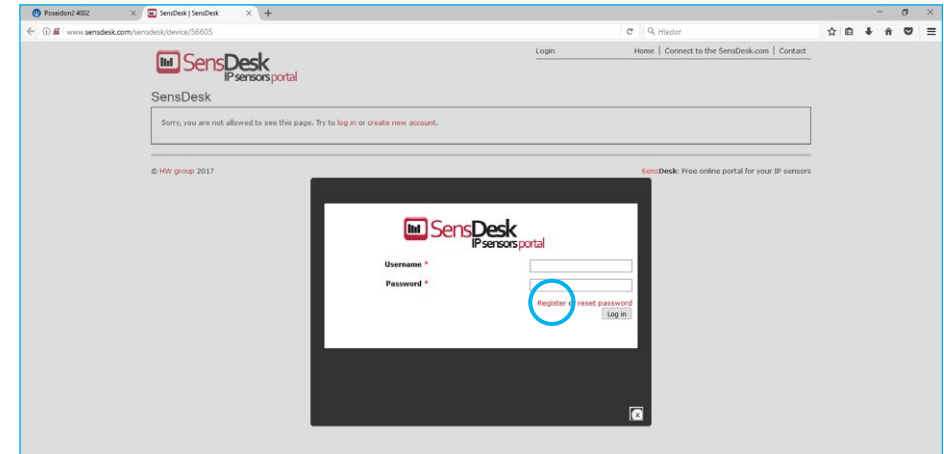
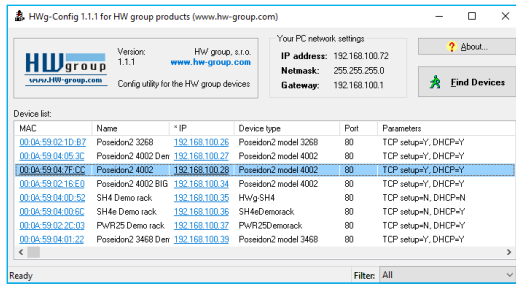

- 3 If you already have a user account, enter your login credentials and the device is automatically linked to your account. Otherwise click the **Register** link. A registration form appears.



- General
- General setup
- Security
- SNMP
- Email
- GSM
- Log & Time
- Portal**
- MQTT
- Sensors
- Inputs
- Outputs
- Virtual Outputs
- System

Poseidon2 4002 PORTAL

Portal Message

Value: SensDesk.com: register your IP sensor.

Portal

Name	Value
Portal Enable:	<input checked="" type="checkbox"/>
Server Address:	www.sensdesk.com/portal.php
IP Port:	80 Default 80
User Name:	
Password:	
Current Push Timer:	0
Current Log Timer:	0
Current Check Timer:	0
Cur. Autopush Block Timer:	0
Retransmit number:	0
Manual Push:	<input type="button" value="Manual Push"/>

Sensors autopush config

Name	ID	Current Value	Autopush
Sensor 240	61964	42.7 %RH	0.0
Sensor 241	55824	23.9 °C	0.0

Digital Inputs (DI) autopush config

Name	ID	Current Value	Autopush
Binary 1	1	0(Off)	<input type="checkbox"/>
Binary 2	2	0(Off)	<input type="checkbox"/>
Binary 3	3	0(Off)	<input type="checkbox"/>
Binary 4	4	0(Off)	<input type="checkbox"/>
Binary 5	5	0(Off)	<input type="checkbox"/>
Binary 6	6	0(Off)	<input type="checkbox"/>
Binary 7	7	0(Off)	<input type="checkbox"/>
Binary 8	8	0(Off)	<input type="checkbox"/>
Binary 9	9	0(Off)	<input type="checkbox"/>
Binary 10	10	0(Off)	<input type="checkbox"/>
Binary 11	11	0(Off)	<input type="checkbox"/>
Binary 12	12	0(Off)	<input type="checkbox"/>
Comm Monitor 1	123	0(Off)	<input type="checkbox"/>

Apply Changes

- 2 WWW interface of the device, **Portal** tab, in **Portal Config** section.
 - Click **Portal Enable**
 - Click **Apply Changes**
 - Click **Manual Push**
 - Click the **SensDesk.com: register your IP sensor** link to go to **SensDesk.com** – login dialog appears (see next page)

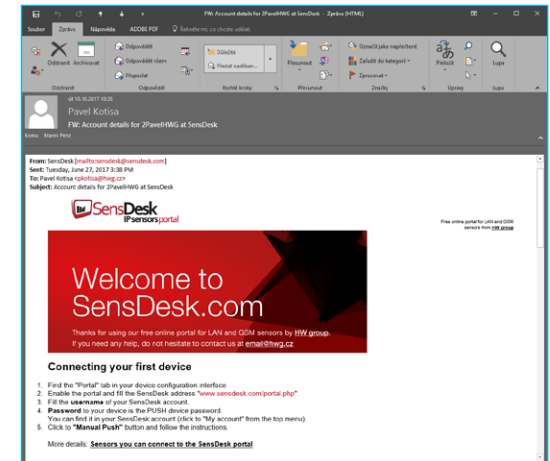
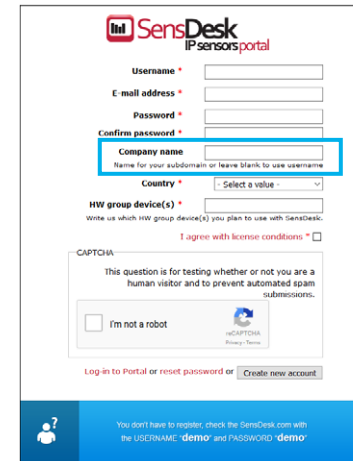

- 4 Fill in your login credentials. The e-mail address must be unique within the portal. The **Company name** field lets you create a third-level domain (such as **company.sensdesk.com**). If the field is left empty, your username is used instead. Click **Create new account** to create your account and send a confirmation e-mail to the address specified. The e-mail contains an activation link.

Posidon2 4002

Check period: Disabled

Address: 192.168.100.71
Port: 80

Username: 2PavelHWG
Password:

ID	State	Sensor Name	Value	Unit	Activity
209,401	✔	Sensor 240	50.1	%RH	1 hour 20 sec ago
209,402	✔	Sensor 241	28.0	°C	1 hour 20 sec ago
209,403	✔	Binary 1	0		1 hour 20 sec ago
209,404	✔	Binary 2	0		1 hour 20 sec ago
209,405	✔	Binary 3	0		1 hour 20 sec ago
209,406	✔	Binary 4	0		1 hour 20 sec ago
209,407	✔	Binary 5	0		1 hour 20 sec ago
209,408	✔	Binary 6	0		1 hour 20 sec ago
209,409	✔	Binary 7	0		1 hour 20 sec ago
209,410	✔	Binary 8	0		1 hour 20 sec ago
209,411	✔	Binary 9	0		1 hour 20 sec ago
209,412	✔	Binary 10	0		1 hour 20 sec ago
209,413	✔	Binary 11	0		1 hour 20 sec ago
209,414	✔	Binary 12	0		1 hour 20 sec ago
209,415	✔	Comm Monitor 1	0		1 hour 20 sec ago
209,416	✔	Pokus	0		1 hour 20 sec ago
209,417	✔	testik	0		1 hour 20 sec ago
209,418	✔	BinOut 3	0		1 hour 20 sec ago
209,419	✔	BinOut 4	0		1 hour 20 sec ago
209,420	✔	VirtBinOut 1	0		1 hour 20 sec ago
209,421	✔	VirtBinOut 2	0		1 hour 20 sec ago
209,422	✔	VirtBinOut 3	0		1 hour 20 sec ago
209,423	✔	VirtBinOut 4	0		1 hour 20 sec ago
209,424	✔	VirtBinOut 5	0		1 hour 20 sec ago
209,425	✔	VirtBinOut 6	0		1 hour 20 sec ago
209,426	✔	VirtBinOut 7	0		1 hour 20 sec ago
209,427	✔	VirtBinOut 8	0		1 hour 20 sec ago

Chart for unit %RH from 2017-11-18 14:03 to 2017-11-20 14:03

Humidity (%RH) | Temperature [C] | Switches [s]

Chart showing Humidity (%RH) over time from 2017-11-18 14:03 to 2017-11-20 14:03. The chart shows a significant spike in humidity around 2017-11-19 07:43, reaching approximately 55% RH.

- 5 After account activation, you are redirected to the Invitation page. Test the portal reaction to your device. When you leave this page, the reaction to changed values increases to up to 15 minutes. If you need a shorter time, fill in the "AutoPush" parameters in the device configuration.

Posidon2 4002

Dashboard | Devices | Sensors | Device groups

2PavelHWG

View | Edit | 3rd party XML integration | Mobile apps

Email

Plaintext email only
No

Portal configuration in devices

PUSH device password
MznXYU

Country: Czech Republic
HW group device(s):
Poseidon2, STE2

History

Member for
3 months 2 weeks

Send this user a private message

© HW group 2017

SensDesk: Free online portal for your IP sensors

- 6 In your user account configuration at [SensDesk.com](https://sensdesk.com) (My Account), there is a **Push Device Password**. This password is stored in the device or the mobile app. The password cannot be changed. For security reasons, it is different from the user account password.

SensDesk Mobile

Uživatel

Jméno
demo

PUSH heslo

Parametry spojeni

Adresa SensDesk serveru
http://m.sensdesk.com

Port SensDesk serveru
80

SensDesk Mobile

Sort by DEVICES

ALL	ALARMS		
Poseidon2 4002 Online Prague	0	Binary 10	
Poseidon2 4002 Online Prague	0	BinOut 1	
Poseidon2 4002 Online Prague	0	BinOut 2	
Poseidon2 4002 Online Prague	0	BinOut 3	
Poseidon2 4002 Online Prague	0	BinOut 4	
Poseidon2 4002 Online Prague	0	Comm Monitor 1	
Poseidon2 4002 Online Prague	sens.INV	Htemp DemoRack	
Poseidon2 4002 Online Prague	25.8 °C	Htemp DemoRack	
Poseidon2 4002 Online Prague	38.9 %RH	Humid2 DemoRack	
Poseidon2 4002 Online Prague	96 lx	Light Demo rack	

- 7 Mobile phone app: SensDesk Mobile. For instructions how to download the free app, see your [SensDesk.com](https://sensdesk.com) account configuration.

PosDamIO and SDK

Poseidon Damocles I/O is a command-line utility for Windows and Linux that lets you control Poseidon2 and Damocles2 units over the XML interface. It can display the states of sensors, inputs and outputs, as well as set an output high or low.

HWg SDK is a library of functions, as well as examples of their use, for Unix and Windows. The functions are intended to help third-party SW solutions communicate with our products over IP. SDK reduces the time needed to implement support for our products into your SW.

For more information: <http://hw-group.us/cs/podpora/kba004-pouziti-damocles2-ve-vasich-programech>

```
Príkazový řádek
C:\Users\volmr.HWg\Desktop>posdamio
Usage: posdamio [OPTIONS] IP_ADDRESS [PORT (default: 80)]

Options:
-g, --get          Get actual values and print list
-o, --output X=Y  Set output X (1..64) or (151..214) to value
                  Y (0, 1, OFF, ON)
-f, --filename SETUP.XML  File with configuration for uploading to the
                  remote device (max. 20000 bytes)
-v, --values VALUES.XML  File to store actual values in XML format
-s, --setup SETUP.XML     File to store remote device configuration
-t, --text DATA.TXT     File to store actual values in text format
-u, --user USER        HTTP authorization user
-p, --password PASSWORD HTTP authorization password

-h, --help          Print this help and exit
--version          Display version information and exit
--error-level      Print error levels and exit

Examples:
posdamio -g 192.168.0.41
posdamio -s c:\data\setup.xml -v c:\data\values.xml 192.168.0.41
posdamio -o 1=ON 192.168.0.41
posdamio -o 1=1 192.168.0.41 8080
posdamio -f setup.xml 192.168.0.41

This application is an example of HW group. The source code you can find
in our HWg SDK on http://www.hw-group.com.

C:\Users\volmr.HWg\Desktop>
```

Formats and interfaces

<http://hw-group.us/product-version/poseidon2damocles2-data-formats>

XML interface description

The XML format is identical for both Poseidon2 and Damocles2 devices.

<http://hw-group.us/product-version/poseidon2damocles2-xml-format>

Modbus over TCP – Interface description

<http://hw-group.us/product-version/poseidon2damocles2-modbustcp>

HWg-netGSM – remote SMS gateway protocol for HW group products

For a current protocol description, see: <http://hw-group.us/product-version/netgsm>.

SNMP – Interface description

<http://hw-group.us/support/snmp-interface-description>

SNMPv3

<http://hw-group.us/support/the-snmp-v3-is-now-supported-in-all-the-poseidon2-units>

HTTPS in Damocles2 and Poseidon2

<http://hw-group.us/support/https-in-poseidon2-and-damocles2>

More monitoring devices by HW group



Damocles2 2404

Secure industrial I/O device with PoE and Telco -48V power options.



Ares 10/12

Remote environment monitoring at any place with GSM coverage.



HWg-SMS-GW3

GSM gateway for sending text messages (SMS) over the Ethernet.



HWg-WLD

Water leak detector, sensitive along the entire length of the absorbing cable.



UPS 12V and 5V

Compact uninterruptible power supplies with power failure indication.



HWg-PWR 3/12/25

Consumption metering with external M-bus meters.



HW group s.r.o.
Formanská 296
Prague, 149 00
Czech Republic

Phone: +420 222 511 918
Fax: +420 222 513 833

www.HW-group.com